

-55V(D-S) P-Channel Enhancement Mode Power MOS FET

General Features

- $V_{DS} = -55V, I_D = -15A$
 $R_{DS(ON)} < 80m\Omega @ V_{GS} = -10V$
- High density cell design for ultra low R_{dson}
- Fully characterized avalanche voltage and current
- Excellent package for good heat dissipation



Lead Free

Application

- Power switching application
- Hard switched and high frequency circuits
- DC-DC Converter

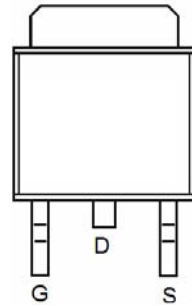

Marking and pin assignment

PIN Configuration

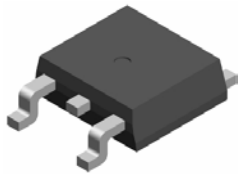

TO-252-2L top view

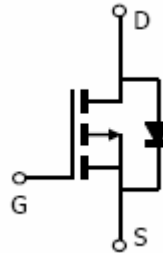

Schematic diagram

Package Marking and Ordering Information

| Device Marking | Device | Device Package | Reel Size | Tape width | Quantity |
|----------------|----------|----------------|-----------|------------|----------|
| MSP0515D | MSP0515D | TO-252-2L | - | - | - |

Absolute Maximum Ratings ($T_C = 25^\circ C$ unless otherwise noted)

| Parameter | Symbol | Limit | Unit |
|--|--------------------|------------|------------|
| Drain-Source Voltage | V_{DS} | -55 | V |
| Gate-Source Voltage | V_{GS} | ± 20 | V |
| Drain Current-Continuous | I_D | -15 | A |
| Drain Current-Continuous($T_C = 100^\circ C$) | $I_D(100^\circ C)$ | -10 | A |
| Pulsed Drain Current | I_{DM} | -50 | A |
| Maximum Power Dissipation | P_D | 50 | W |
| Operating Junction and Storage Temperature Range | T_J, T_{STG} | -55 To 150 | $^\circ C$ |

Thermal Characteristic

| | | | |
|--|-----------------|-----|---------------|
| Thermal Resistance ,Junction-to-Case ^(Note 2) | $R_{\theta JC}$ | 2.5 | $^{\circ}C/W$ |
|--|-----------------|-----|---------------|

Electrical Characteristics ($T_C=25^{\circ}C$ unless otherwise noted)

| Parameter | Symbol | Condition | Min | Typ | Max | Unit |
|--|--------------|---|------|------|-----------|------------|
| Off Characteristics | | | | | | |
| Drain-Source Breakdown Voltage | BV_{DSS} | $V_{GS}=0V, I_D=-250\mu A$ | -55 | - | - | V |
| Zero Gate Voltage Drain Current | I_{DSS} | $V_{DS}=-55V, V_{GS}=0V$ | - | - | 1 | μA |
| Gate-Body Leakage Current | I_{GSS} | $V_{GS}=\pm 20V, V_{DS}=0V$ | - | - | ± 100 | nA |
| On Characteristics ^(Note 3) | | | | | | |
| Gate Threshold Voltage | $V_{GS(th)}$ | $V_{DS}=V_{GS}, I_D=-250\mu A$ | -1.5 | -2.3 | -3.5 | V |
| Drain-Source On-State Resistance | $R_{DS(ON)}$ | $V_{GS}=-10V, I_D=-5A$ | - | 64 | 80 | m Ω |
| Forward Transconductance | g_{FS} | $V_{DS}=-15V, I_D=-5A$ | 16 | - | - | S |
| Dynamic Characteristics ^(Note 4) | | | | | | |
| Input Capacitance | C_{iss} | $V_{DS}=-20V, V_{GS}=0V,$ $F=1.0MHz$ | - | 1450 | - | PF |
| Output Capacitance | C_{oss} | | - | 145 | - | PF |
| Reverse Transfer Capacitance | C_{rss} | | - | 110 | - | PF |
| Switching Characteristics ^(Note 4) | | | | | | |
| Turn-on Delay Time | $t_{d(on)}$ | $V_{DD}=-30V, R_L=30\Omega$ $V_{GS}=-10V, R_{GEN}=6\Omega$ | - | 8 | - | nS |
| Turn-on Rise Time | t_r | | - | 9 | - | nS |
| Turn-Off Delay Time | $t_{d(off)}$ | | - | 65 | - | nS |
| Turn-Off Fall Time | t_f | | - | 30 | - | nS |
| Total Gate Charge | Q_g | $V_{DS}=-30V, I_D=-5A,$ $V_{GS}=-10V$ | - | 26 | - | nC |
| Gate-Source Charge | Q_{gs} | | - | 4.5 | - | nC |
| Gate-Drain Charge | Q_{gd} | | - | 7 | - | nC |
| Drain-Source Diode Characteristics | | | | | | |
| Diode Forward Voltage ^(Note 3) | V_{SD} | $V_{GS}=0V, I_S=-3A$ | - | - | 1.2 | V |
| Diode Forward Current ^(Note 2) | I_S | | - | - | -15 | A |

Notes:

1. Repetitive Rating: Pulse width limited by maximum junction temperature.
2. Surface Mounted on FR4 Board, $t \leq 10$ sec.
3. Pulse Test: Pulse Width $\leq 300\mu s$, Duty Cycle $\leq 2\%$.
4. Guaranteed by design, not subject to production

Test Circuit

1) E_{AS} Test Circuit

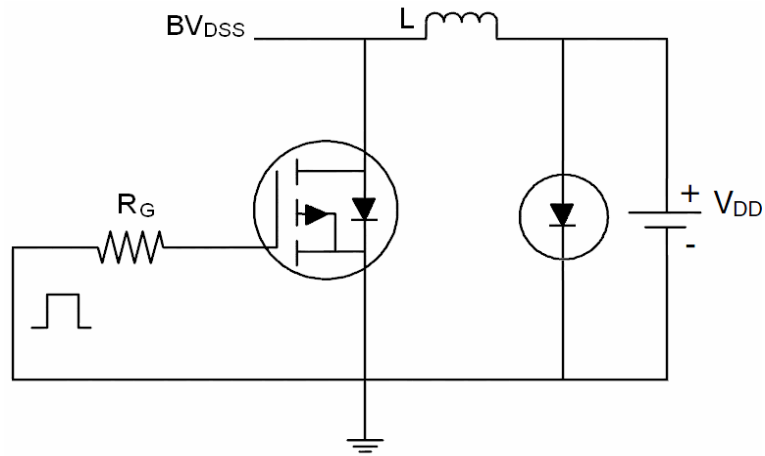

2) Gate Charge Test Circuit

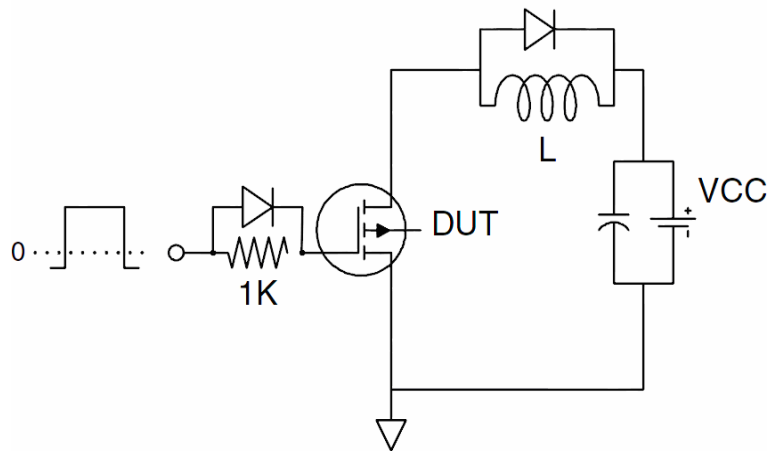

3) Switch Time Test Circuit

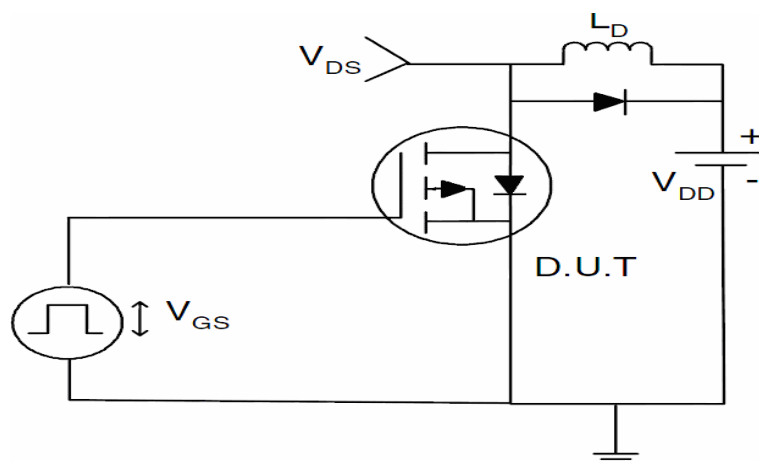

Typical Electrical and Thermal Characteristics (Curves)

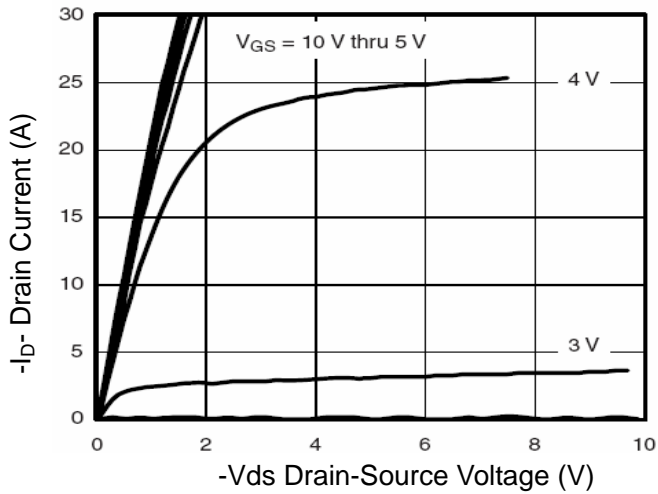

Figure 1 Output Characteristics

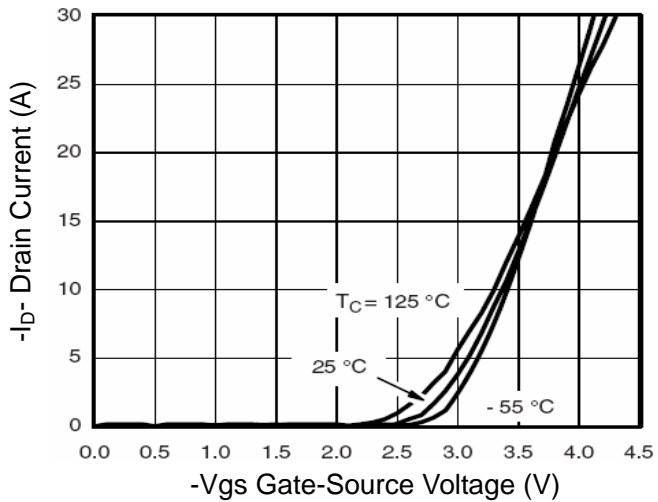

Figure 2 Transfer Characteristics

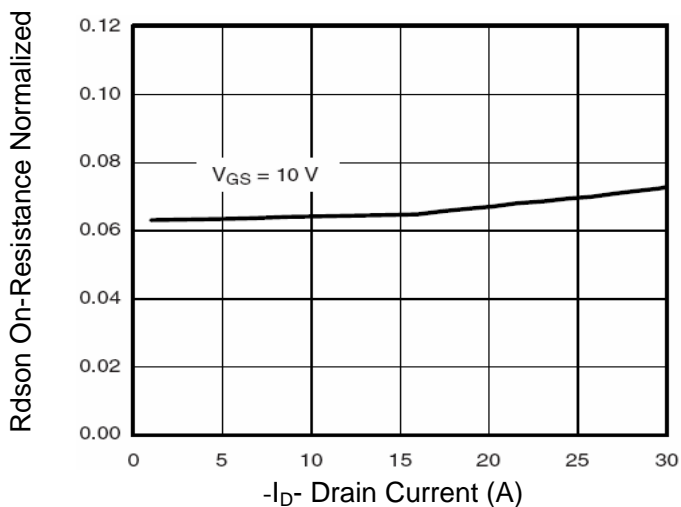

Figure 3 Rds(on)- Drain Current

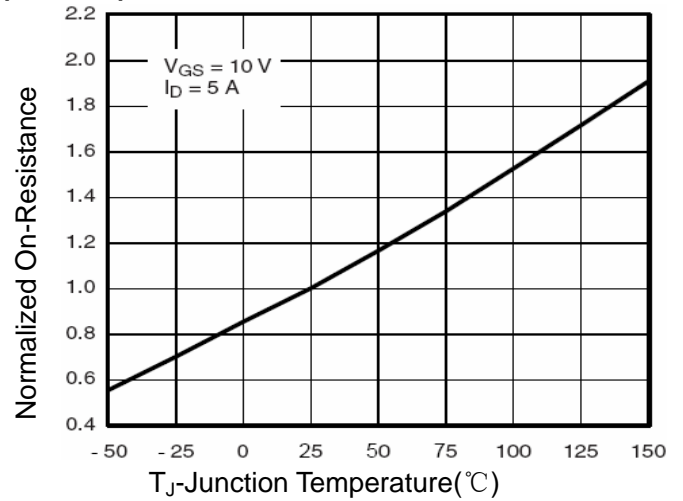

Figure 4 Rds(on)-Junction Temperature

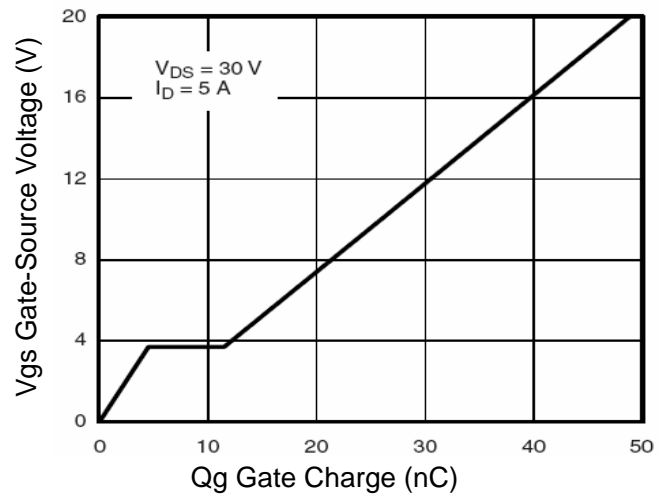

Figure 5 Gate Charge

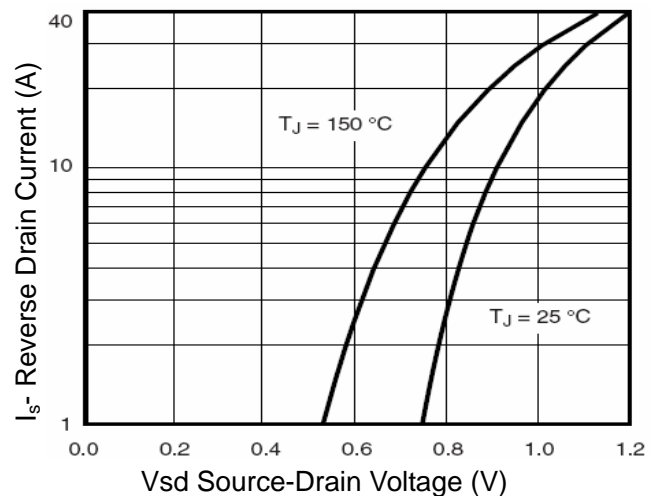

Figure 6 Source- Drain Diode Forward

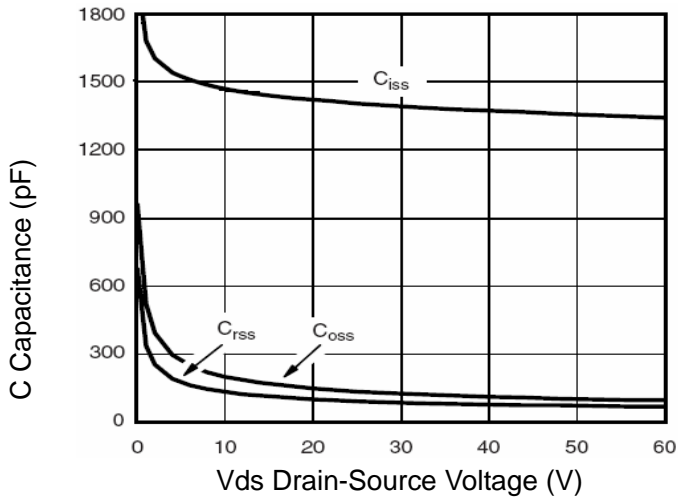

Figure 7 Capacitance vs Vds

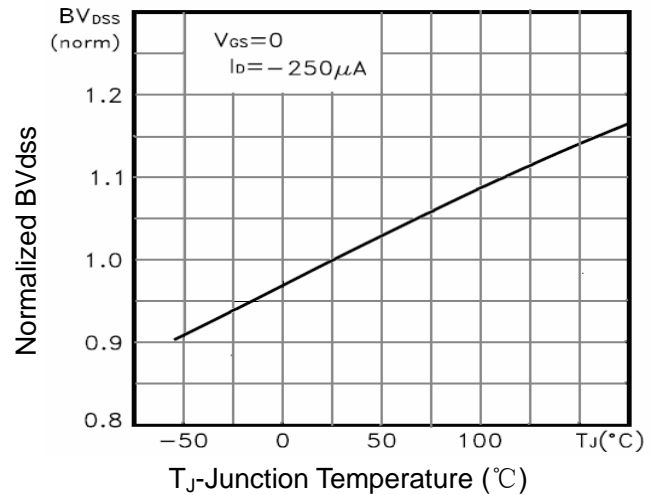

Figure 9 BV_{DSS} vs Junction Temperature

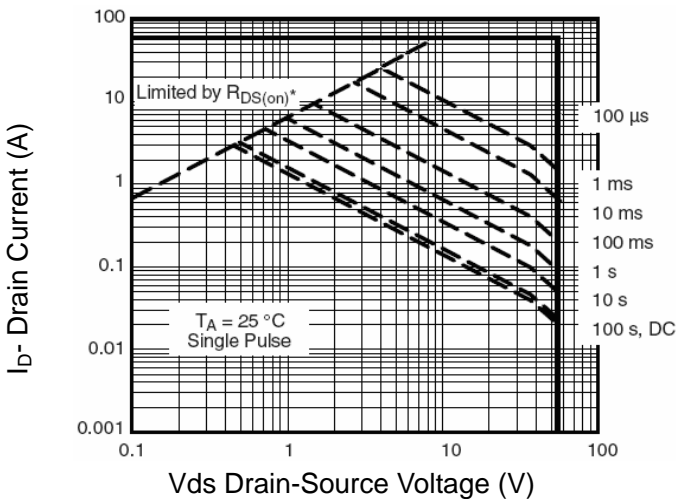

Figure 8 Safe Operation Area

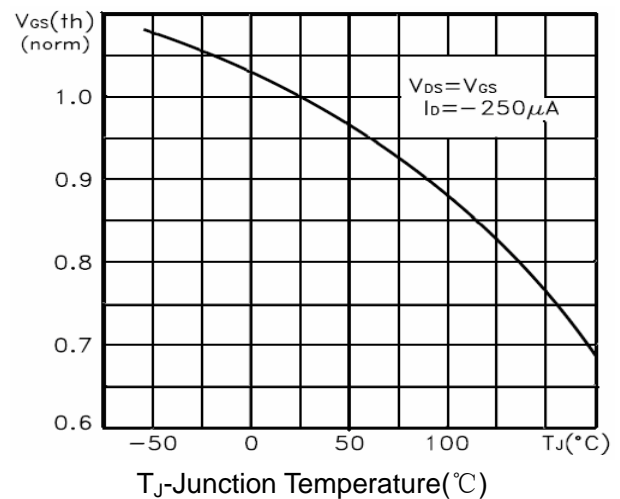

Figure 10 $V_{GS(th)}$ vs Junction Temperature

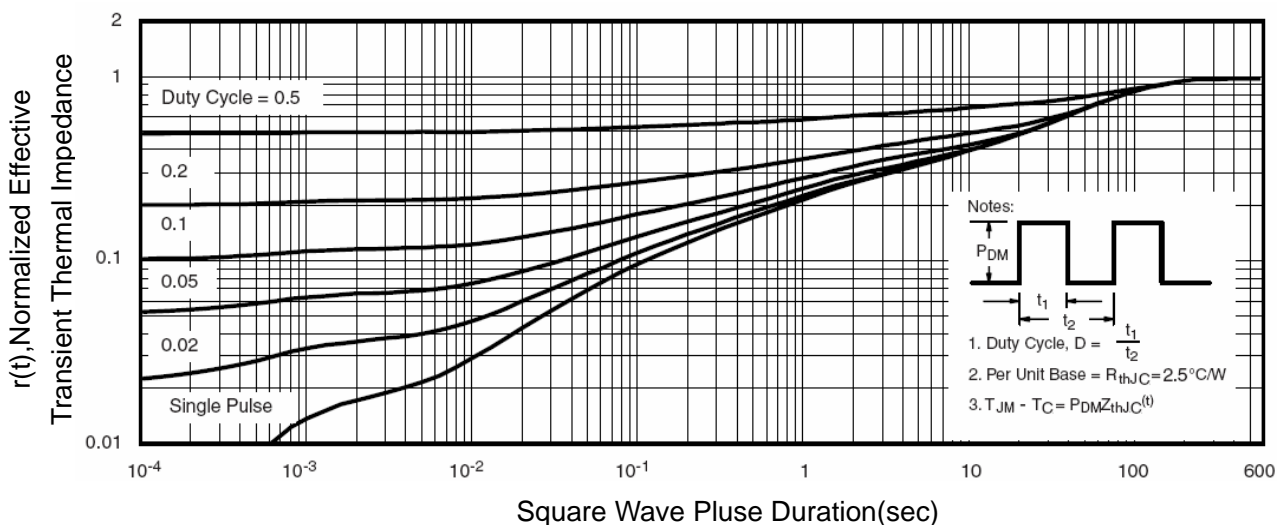
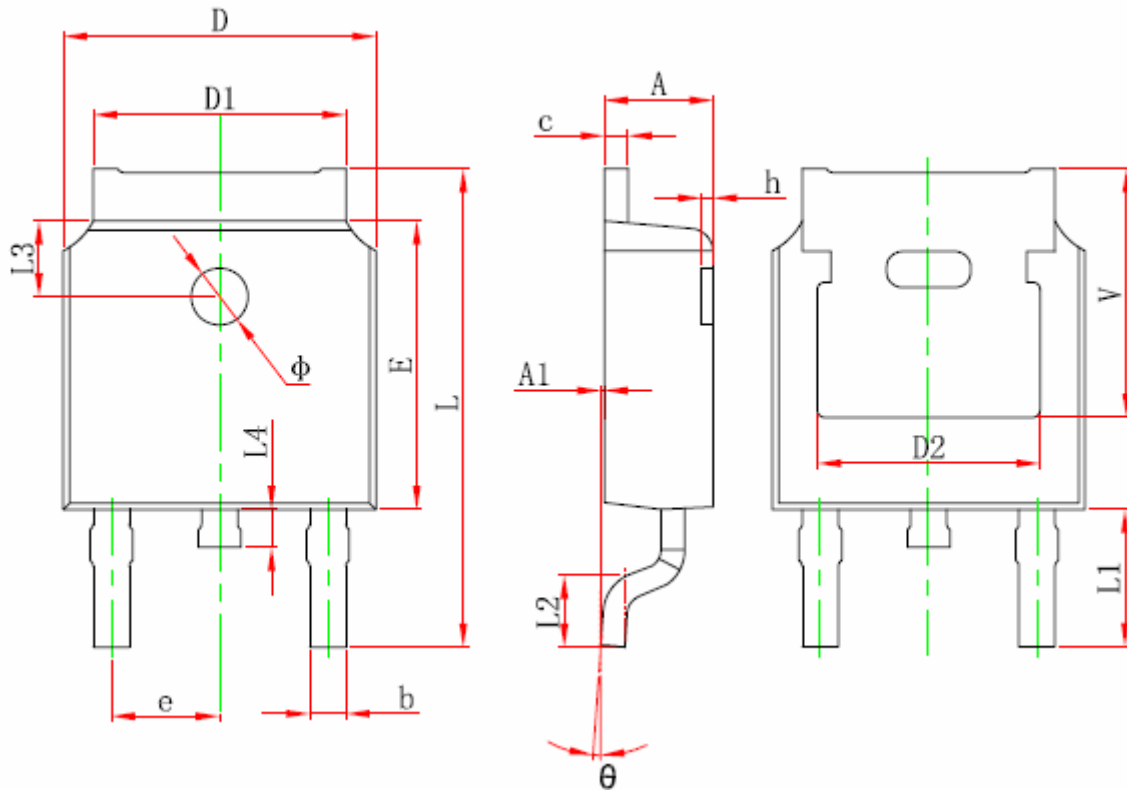

Figure 11 Normalized Maximum Transient Thermal Impedance

TO-252-2L Package Information



| Symbol | Dimensions In Millimeters | | Dimensions In Inches | |
|----------|---------------------------|--------|----------------------|-------|
| | Min. | Max. | Min. | Max. |
| A | 2.200 | 2.400 | 0.087 | 0.094 |
| A1 | 0.000 | 0.127 | 0.000 | 0.005 |
| b | 0.660 | 0.860 | 0.026 | 0.034 |
| c | 0.460 | 0.580 | 0.018 | 0.023 |
| D | 6.500 | 6.700 | 0.256 | 0.264 |
| D1 | 5.100 | 5.460 | 0.201 | 0.215 |
| D2 | 4.830 REF. | | 0.190 REF. | |
| E | 6.000 | 6.200 | 0.236 | 0.244 |
| e | 2.186 | 2.386 | 0.086 | 0.094 |
| L | 9.800 | 10.400 | 0.386 | 0.409 |
| L1 | 2.900 REF. | | 0.114 REF. | |
| L2 | 1.400 | 1.700 | 0.055 | 0.067 |
| L3 | 1.600 REF. | | 0.063 REF. | |
| L4 | 0.600 | 1.000 | 0.024 | 0.039 |
| ϕ | 1.100 | 1.300 | 0.043 | 0.051 |
| θ | 0° | 8° | 0° | 8° |
| h | 0.000 | 0.300 | 0.000 | 0.012 |
| V | 5.350 REF. | | 0.211 REF. | |