

**-30V(D-S) P-Channel Enhancement Mode Power MOS FET**

**GENERAL FEATURES**

- $V_{DS} = -30V, I_D = -9.1A$   
 $R_{DS(ON)} < 35m\Omega @ V_{GS} = -4.5V$   
 $R_{DS(ON)} < 20m\Omega @ V_{GS} = -10V$
- High Power and current handing capability
- Lead free product is acquired
- Surface Mount Package



**Lead Free**

**Application**

- Battery Switch
- Load switch
- Power management

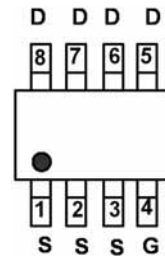

**Marking and pin Assignment**

**PIN Configuration**

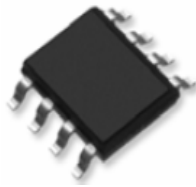

**SOP-8 top view**

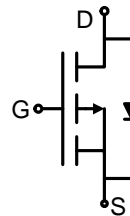

**Schematic diagram**

**Package Marking And Ordering Information**

Device Marking	Device	Device Package	Reel Size	Tape width	Quantity
MSP0309W	MSP0309W	SOP-8	Ø330mm	12mm	2500 units

**Absolute Maximum Ratings (TA=25°C unless otherwise noted)**

Parameter	Symbol	Limit	Unit	
Drain-Source Voltage	$V_{DS}$	-30	V	
Gate-Source Voltage	$V_{GS}$	±20	V	
Continuous Drain Current ( $T_J = 150^\circ C$ )	$I_D$	$T_C = 25^\circ C$	-11	A
		$T_C = 70^\circ C$	-9	
		$T_A = 25^\circ C$	-9.1	
		$T_A = 70^\circ C$	-7.2	
Drain Current-Pulsed (Note 1)	$I_{DM}$	-50	A	
Maximum Power Dissipation	$P_D$	3.1	W	
Operating Junction and Storage Temperature Range	$T_J, T_{STG}$	-55 To 150	°C	

**Thermal Characteristic**

Thermal Resistance, Junction-to-Ambient (Note 2)	$R_{\theta JA}$	40	°C/W
--------------------------------------------------	-----------------	----	------

**Electrical Characteristics (T<sub>A</sub>=25°C unless otherwise noted)**

Parameter	Symbol	Condition	Min	Typ	Max	Unit
<b>Off Characteristics</b>						
Drain-Source Breakdown Voltage	BV <sub>DSS</sub>	V <sub>GS</sub> =0V I <sub>D</sub> =-250μA	-30	-33	-	V
Zero Gate Voltage Drain Current	I <sub>DSS</sub>	V <sub>DS</sub> =-30V, V <sub>GS</sub> =0V	-	-	-1	μA
Gate-Body Leakage Current	I <sub>GSS</sub>	V <sub>GS</sub> =±20V, V <sub>DS</sub> =0V	-	-	±100	nA
<b>On Characteristics (Note 3)</b>						
Gate Threshold Voltage	V <sub>GS(th)</sub>	V <sub>DS</sub> =V <sub>GS</sub> , I <sub>D</sub> =-250μA	-1	-1.5	-3	V
Drain-Source On-State Resistance	R <sub>DS(ON)</sub>	V <sub>GS</sub> =-10V, I <sub>D</sub> =-9.1A	-	15	20	mΩ
		V <sub>GS</sub> =-4.5V, I <sub>D</sub> =-6.9A	-	21	35	mΩ
Forward Transconductance	g <sub>FS</sub>	V <sub>DS</sub> =-15V, I <sub>D</sub> =-9.1A	10	-	-	S
<b>Dynamic Characteristics (Note4)</b>						
Input Capacitance	C <sub>ISS</sub>	V <sub>DS</sub> =-15V, V <sub>GS</sub> =0V, F=1.0MHz	-	1600	-	PF
Output Capacitance	C <sub>OSS</sub>		-	350	-	PF
Reverse Transfer Capacitance	C <sub>RSS</sub>		-	300	-	PF
<b>Switching Characteristics (Note 4)</b>						
Turn-on Delay Time	t <sub>d(on)</sub>	V <sub>DD</sub> =-15V, I <sub>D</sub> =-1A, V <sub>GS</sub> =-10V, R <sub>GEN</sub> =6Ω	-	10	-	nS
Turn-on Rise Time	t <sub>r</sub>		-	15	-	nS
Turn-Off Delay Time	t <sub>d(off)</sub>		-	110	-	nS
Turn-Off Fall Time	t <sub>f</sub>		-	70	-	nS
Total Gate Charge	Q <sub>g</sub>	V <sub>DS</sub> =-15V, I <sub>D</sub> =-9.1A V <sub>GS</sub> =-10V	-	30	-	nC
Gate-Source Charge	Q <sub>gs</sub>		-	5.5	-	nC
Gate-Drain Charge	Q <sub>gd</sub>		-	8	-	nC
<b>Drain-Source Diode Characteristics</b>						
Diode Forward Voltage (Note 3)	V <sub>SD</sub>	V <sub>GS</sub> =0V, I <sub>S</sub> =-2.1A	-	-	-1.2	V

**Notes:**

1. Repetitive Rating: Pulse width limited by maximum junction temperature.
2. Surface Mounted on FR4 Board, t ≤ 10 sec.
3. Pulse Test: Pulse Width ≤ 300μs, Duty Cycle ≤ 2%.
4. Guaranteed by design, not subject to production

**TYPICAL ELECTRICAL AND THERMAL CHARACTERISTICS**



**Figure 1: Switching Test Circuit**

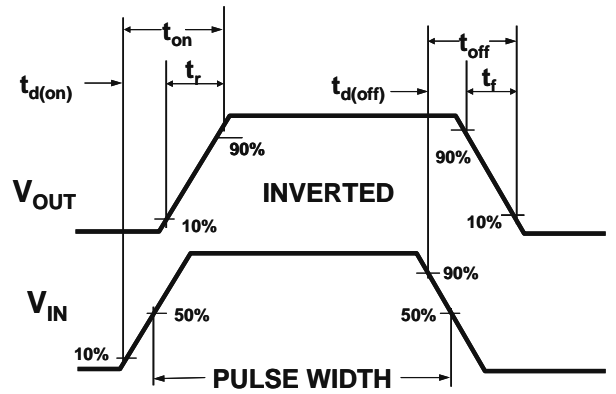

**Figure 2: Switching Waveforms**

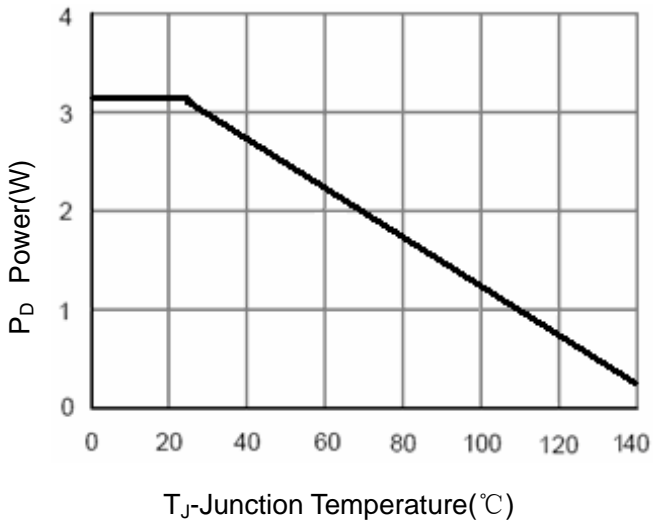

**Figure 3 Power Dissipation**

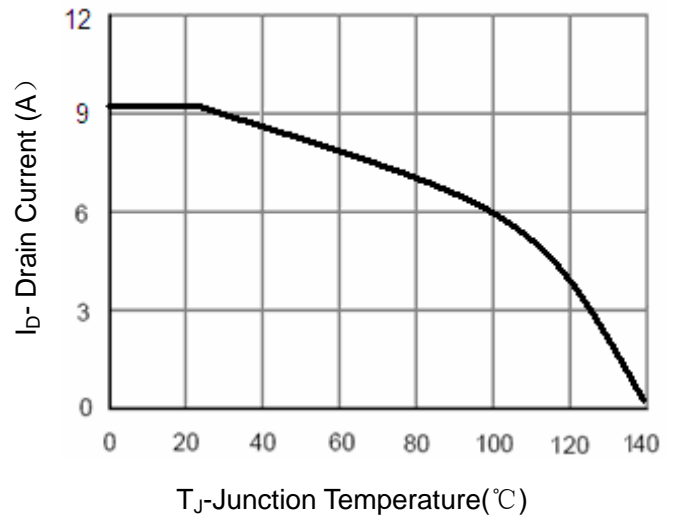

**Figure 4 Drain Current**

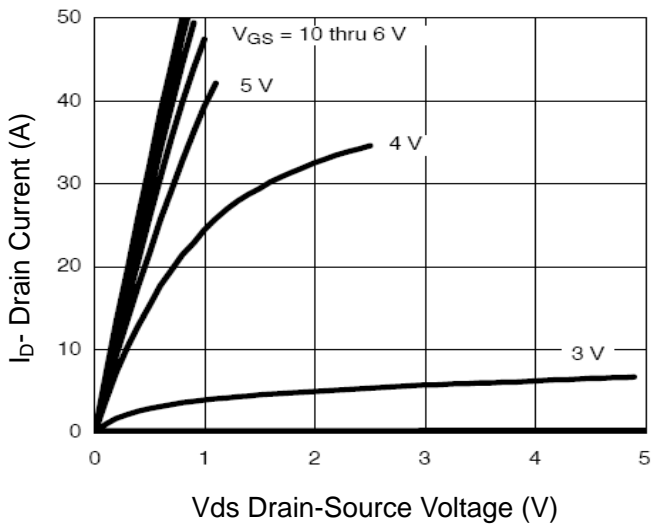

**Figure 5 Output CHARACTERISTICS**

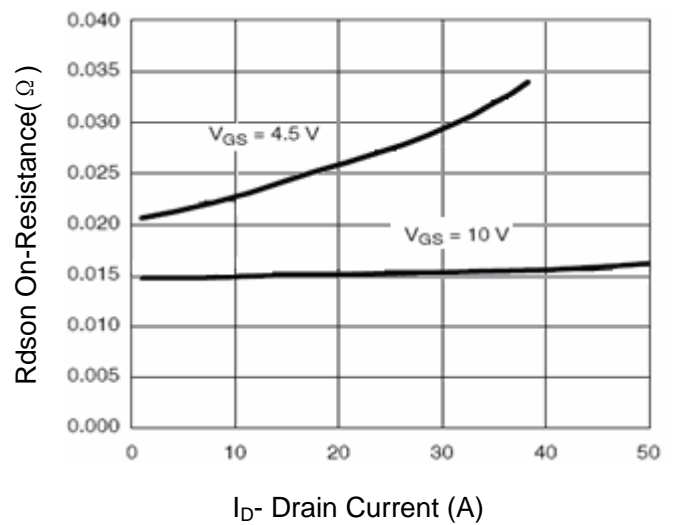

**Figure 6 Drain-Source On-Resistance**

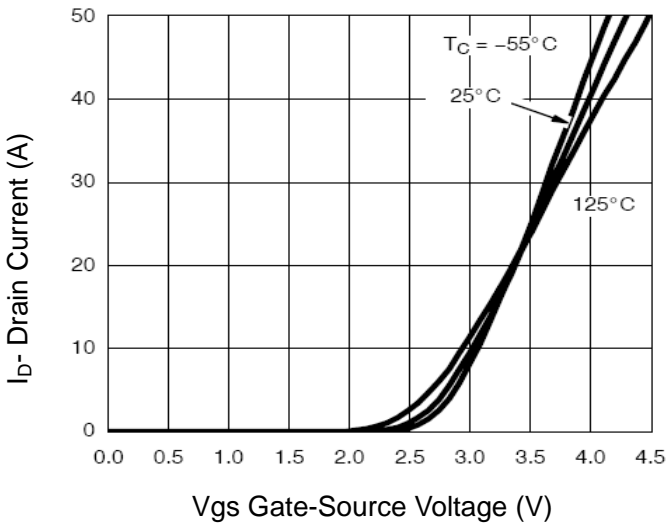

Figure 7 Transfer Characteristics

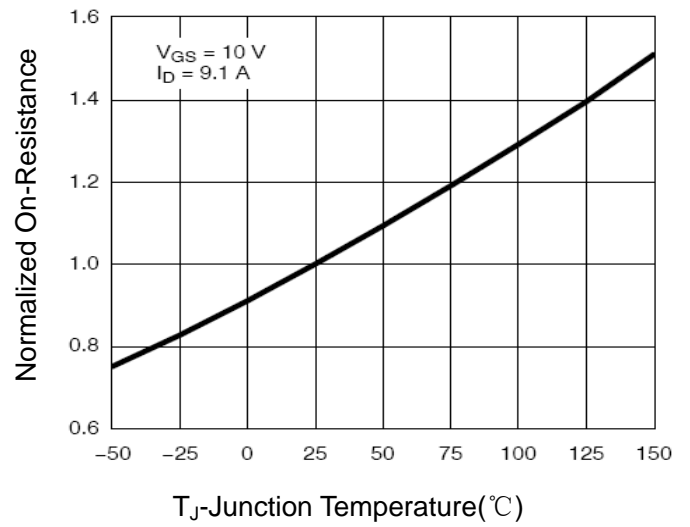

Figure 8 Drain-Source On-Resistance

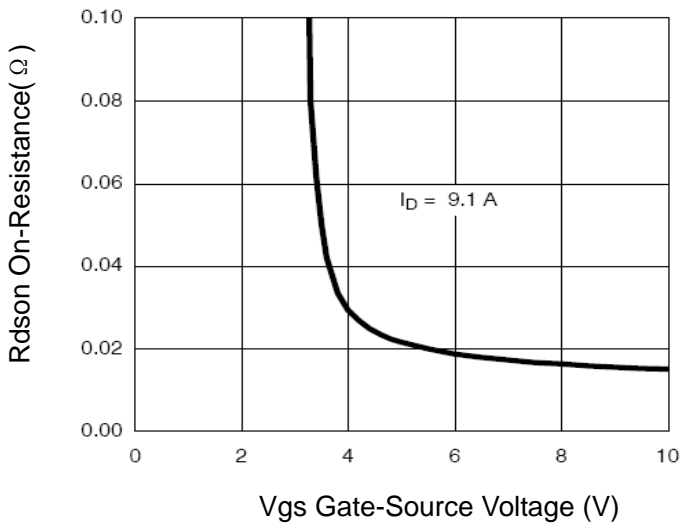

Figure 9  $R_{DS(on)}$  vs  $V_{GS}$

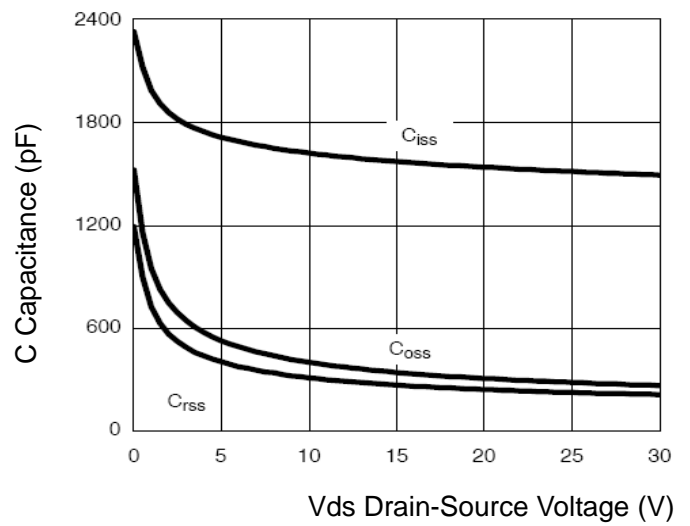

Figure 10 Capacitance vs  $V_{DS}$

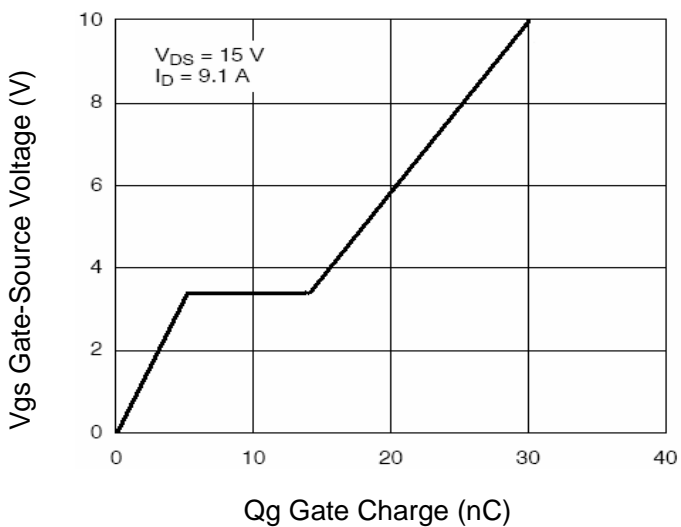

Figure 11 Gate Charge

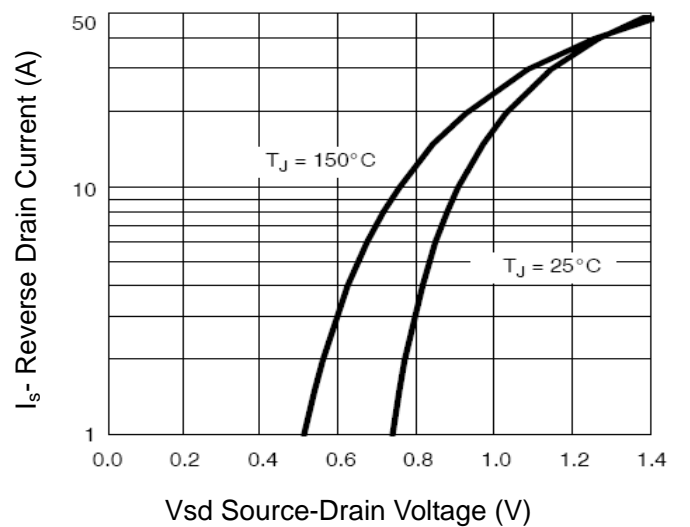

Figure 12 Source- Drain Diode Forward

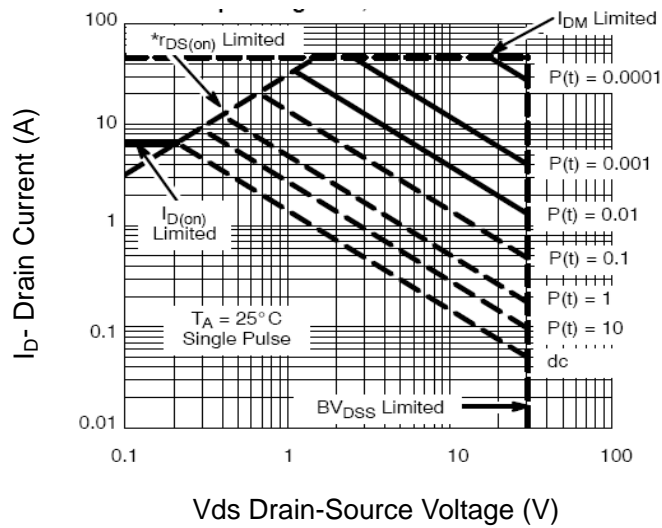

Figure 13 Safe Operation Area

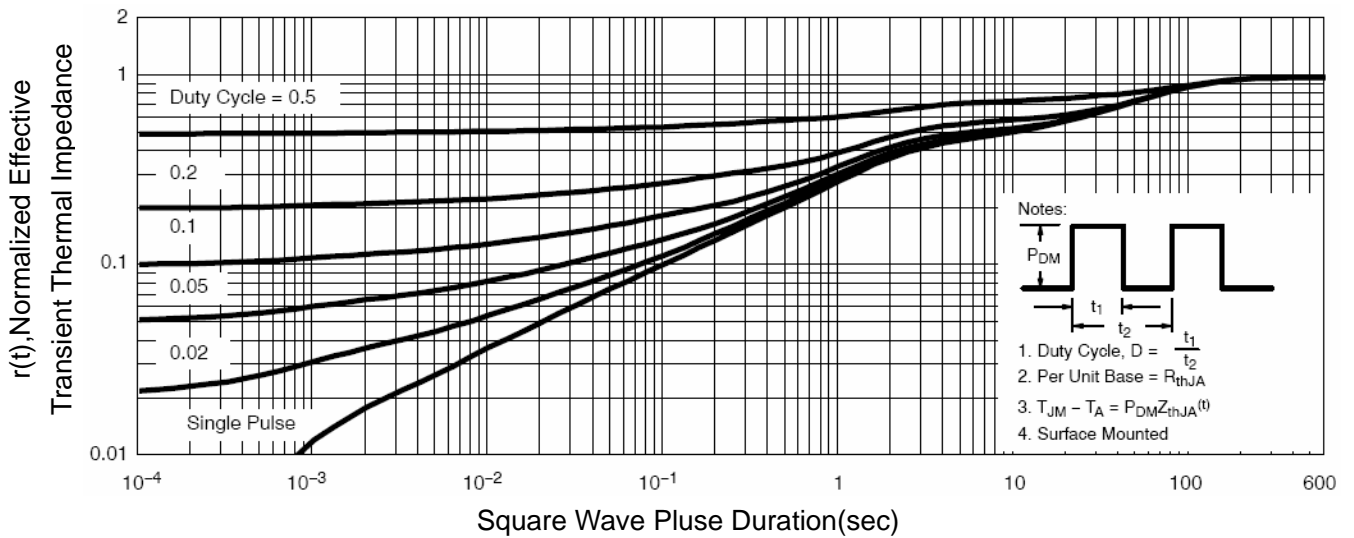
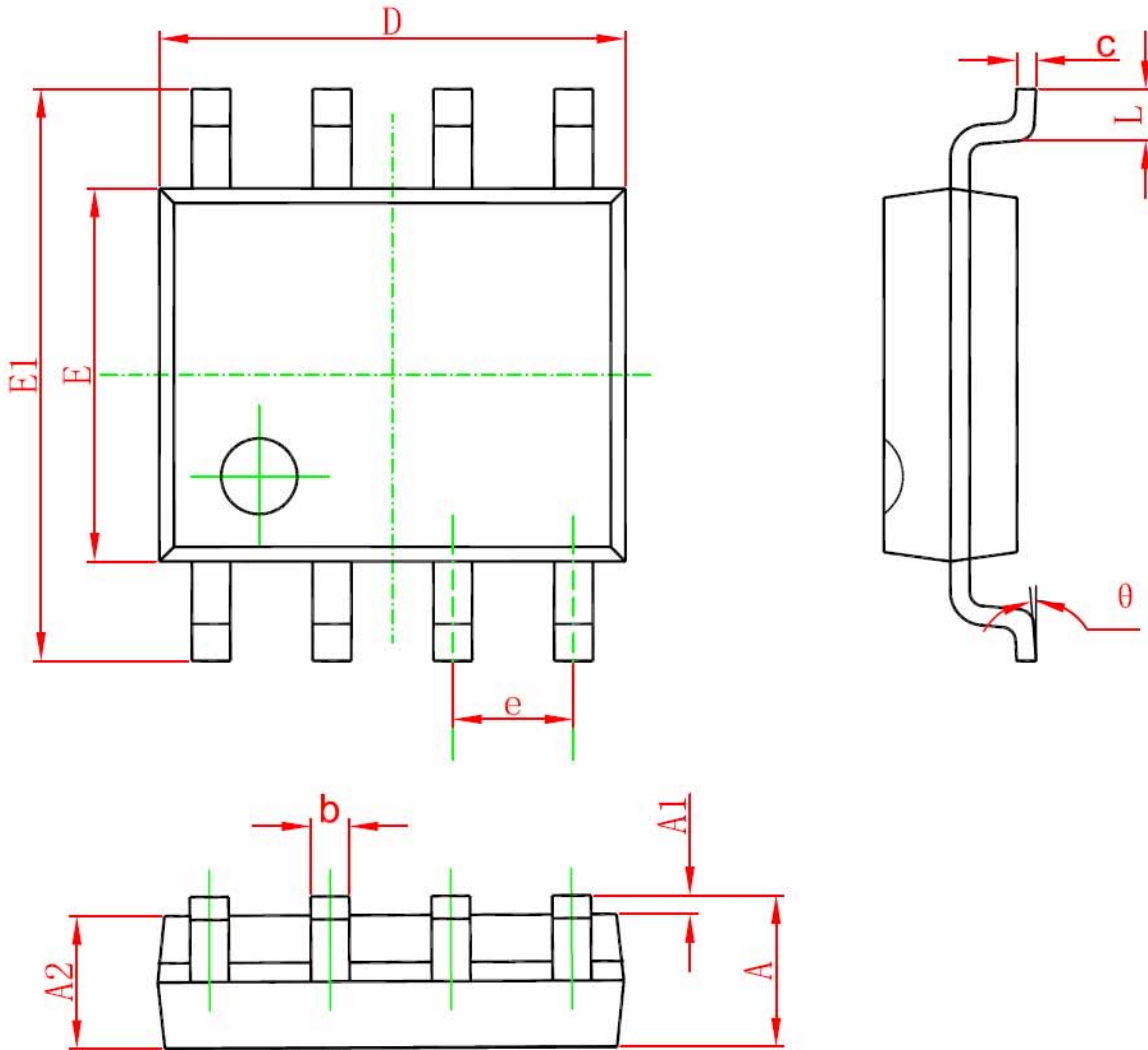

Figure 14 Normalized Maximum Transient Thermal Impedance

SOP-8 PACKAGE IN FORMATION



Symbol	Dimensions In Millimeters		Dimensions In Inches	
	Min	Max	Min	Max
A	1.350	1.750	0.053	0.069
A1	0.100	0.250	0.004	0.010
A2	1.350	1.550	0.053	0.061
b	0.330	0.510	0.013	0.020
c	0.170	0.250	0.006	0.010
D	4.700	5.100	0.185	0.200
E	3.800	4.000	0.150	0.157
E1	5.800	6.200	0.228	0.244
e	1.270 (BSC)		0.050 (BSC)	
L	0.400	1.270	0.016	0.050
θ	0°	8°	0°	8°