

-20V(D-S) P-Channel Enhancement Mode Power MOS FET

General Features

- $V_{DS} = -20V, I_D = -3.9A$
 $R_{DS(ON)} < 70m\Omega @ V_{GS} = -2.5V$
 $R_{DS(ON)} < 50m\Omega @ V_{GS} = -4.5V$
- High power and current handling capability
- Lead free product is acquired
- Surface mount package



Lead Free

Application

- PA switch
- Load switch
- Power management

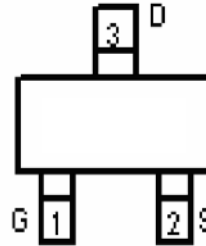

Marking and pin assignment

PIN Configuration



SOT-23 top view

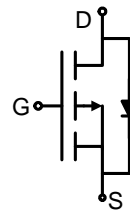

Schematic diagram

Package Marking and Ordering Information

Device Marking	Device	Device Package	Reel Size	Tape width	Quantity
	MSP0204	SOT-23	Ø180mm	8 mm	3000 units

Absolute Maximum Ratings ($T_A = 25^\circ C$ unless otherwise noted)

Parameter	Symbol	Limit	Unit
Drain-Source Voltage	V_{DS}	-20	V
Gate-Source Voltage	V_{GS}	± 12	V
Drain Current -Continuous	I_D	-3.9	A
Drain Current -Pulsed ^(Note 1)	I_{DM}	-12	A
Maximum Power Dissipation	P_D	1.4	W
Operating Junction and Storage Temperature Range	T_J, T_{STG}	-55 To 150	$^\circ C$

Thermal Characteristic

Thermal Resistance, Junction-to-Ambient ^(Note 2)	$R_{\theta JA}$	89	$^\circ C/W$
---	-----------------	----	--------------

Electrical Characteristics (T_A=25°C unless otherwise noted)

Parameter	Symbol	Condition	Min	Typ	Max	Unit
Off Characteristics						
Drain-Source Breakdown Voltage	BV _{DSS}	V _{GS} =0V I _D =-250μA	-20	-	-	V
Zero Gate Voltage Drain Current	I _{DSS}	V _{DS} =-20V, V _{GS} =0V	-	-	-1	μA
Gate-Body Leakage Current	I _{GSS}	V _{GS} =±12V, V _{DS} =0V	-	-	±100	nA
On Characteristics (Note 3)						
Gate Threshold Voltage	V _{GS(th)}	V _{DS} =V _{GS} , I _D =-250μA	-0.45	-0.75	-1.0	V
Drain-Source On-State Resistance	R _{DS(on)}	V _{GS} =-4.5V, I _D =-3.3A	-	37	50	mΩ
		V _{GS} =-2.5V, I _D =-3.0A	-	48	70	
Forward Transconductance	g _{FS}	V _{DS} =-5V, I _D =-3.0A	5	-	-	S
Dynamic Characteristics (Note4)						
Input Capacitance	C _{iss}	V _{DS} =-10V, V _{GS} =0V, F=1.0MHz	-	560	-	PF
Output Capacitance	C _{oss}		-	80	-	PF
Reverse Transfer Capacitance	C _{rss}		-	70	-	PF
Switching Characteristics (Note 4)						
Turn-on Delay Time	t _{d(on)}	V _{DD} =-10V, I _D =-3.3A , R _L =2.2Ω, V _{GS} =-4.5V, R _g =6Ω	-	12	-	nS
Turn-on Rise Time	t _r		-	35	-	nS
Turn-Off Delay Time	t _{d(off)}		-	55	-	nS
Turn-Off Fall Time	t _f		-	40	-	nS
Total Gate Charge	Q _g	V _{DS} =-10V, I _D =-3.3A, V _{GS} =-4.5V	-	8.5	-	nC
Gate-Source Charge	Q _{gs}		-	1.2	-	nC
Gate-Drain Charge	Q _{gd}		-	2.1	-	nC
Drain-Source Diode Characteristics						
Diode Forward Voltage (Note 3)	V _{SD}	V _{GS} =0V, I _S =-3.9A	-	-	-1.2	V
Diode Forward Current (Note 2)	I _S		-	-	-3.9	A

Notes:

1. Repetitive Rating: Pulse width limited by maximum junction temperature.
2. Surface Mounted on FR4 Board, t ≤ 10 sec.
3. Pulse Test: Pulse Width ≤ 300μs, Duty Cycle ≤ 2%.
4. Guaranteed by design, not subject to production

Typical Electrical and Thermal Characteristics



Figure 1: Switching Test Circuit

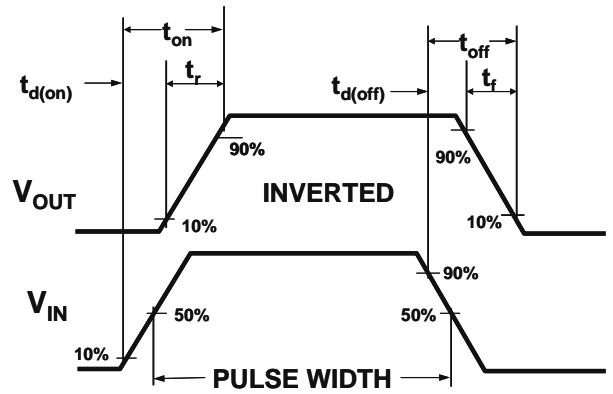

Figure 2: Switching Waveforms

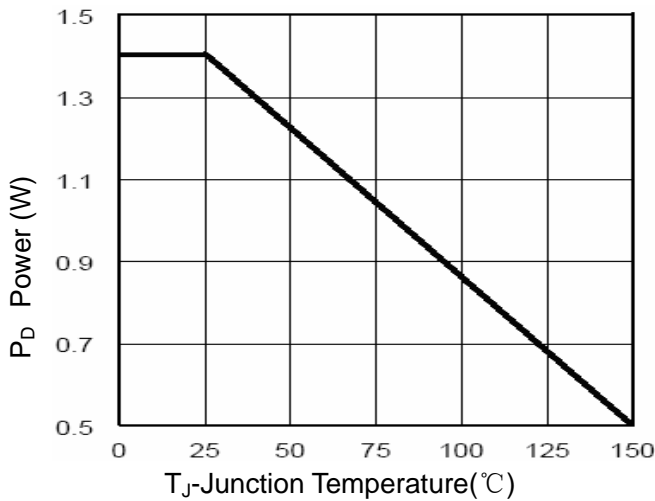

Figure 3 Power Dissipation

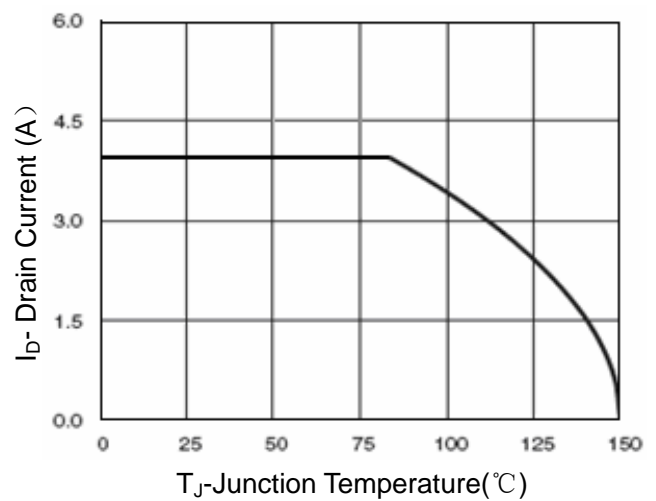

Figure 4 Drain Current

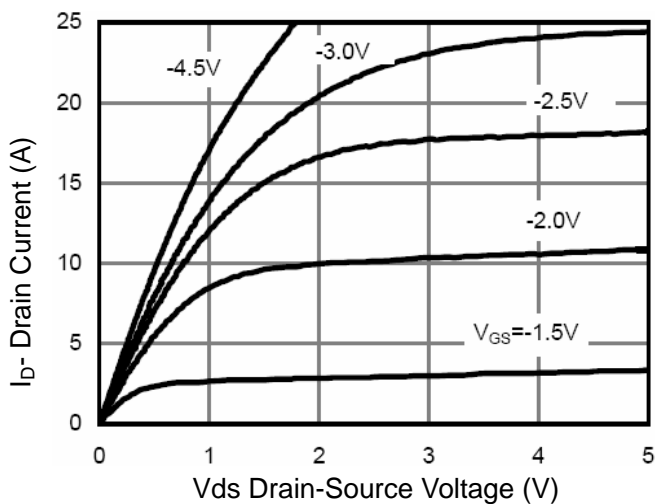

Figure 5 Output Characteristics

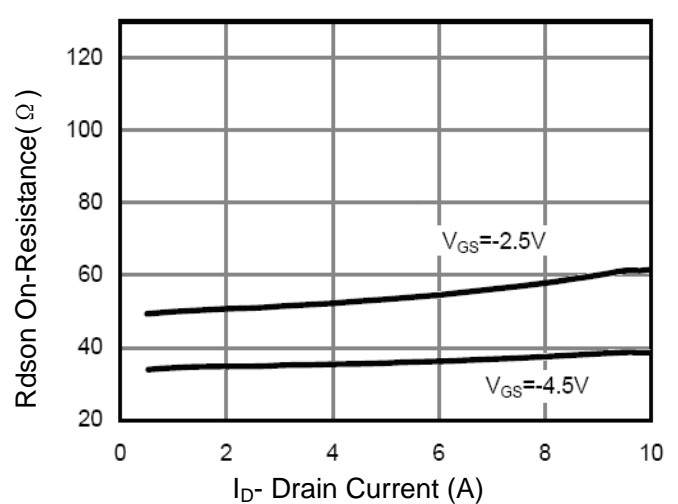

Figure 6 Drain-Source On-Resistance

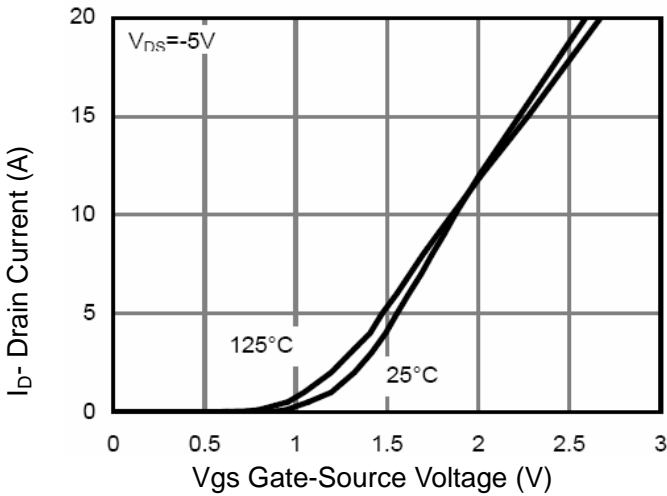

Figure 7 Transfer Characteristics

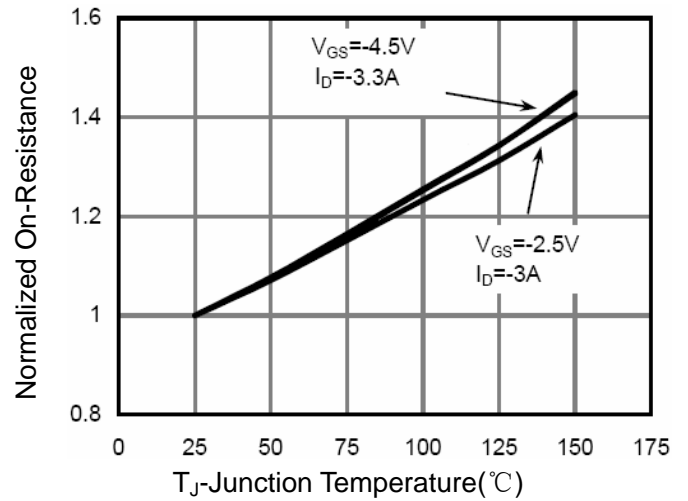

Figure 8 Drain-Source On-Resistance

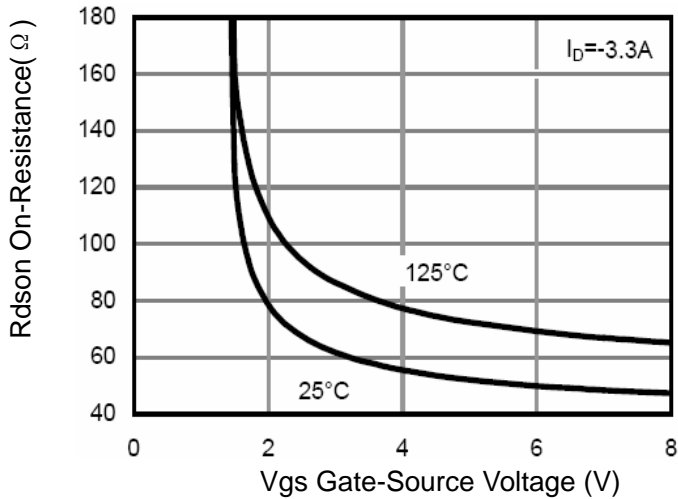

Figure 9 $R_{DS(on)}$ vs V_{GS}

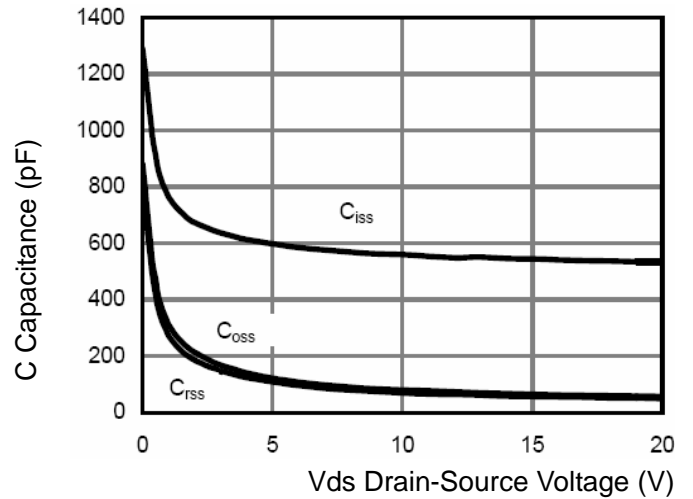

Figure 10 Capacitance vs V_{DS}

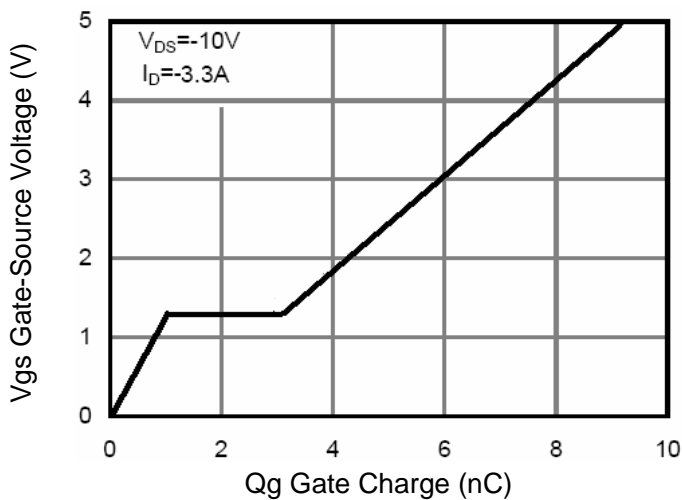

Figure 11 Gate Charge

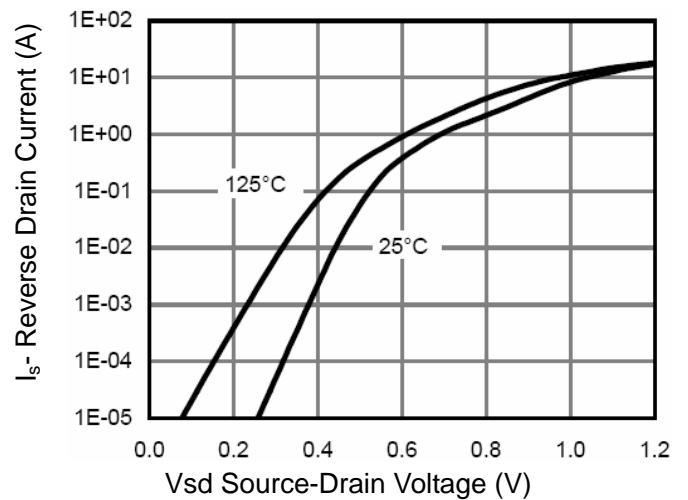

Figure 12 Source-Drain Diode Forward

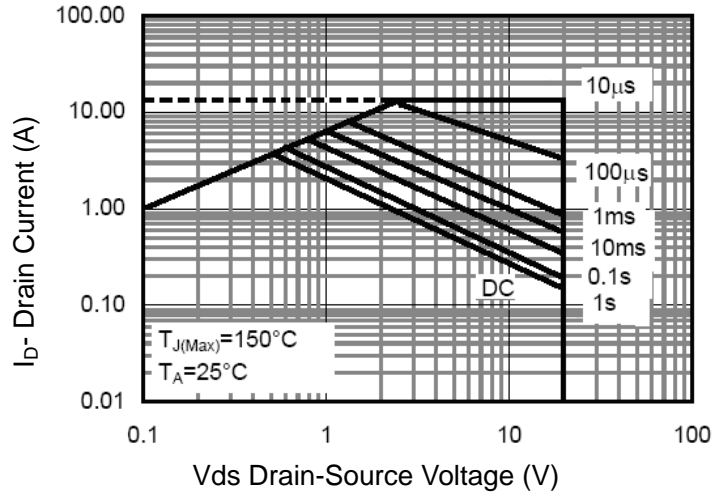

Figure 13 Safe Operation Area

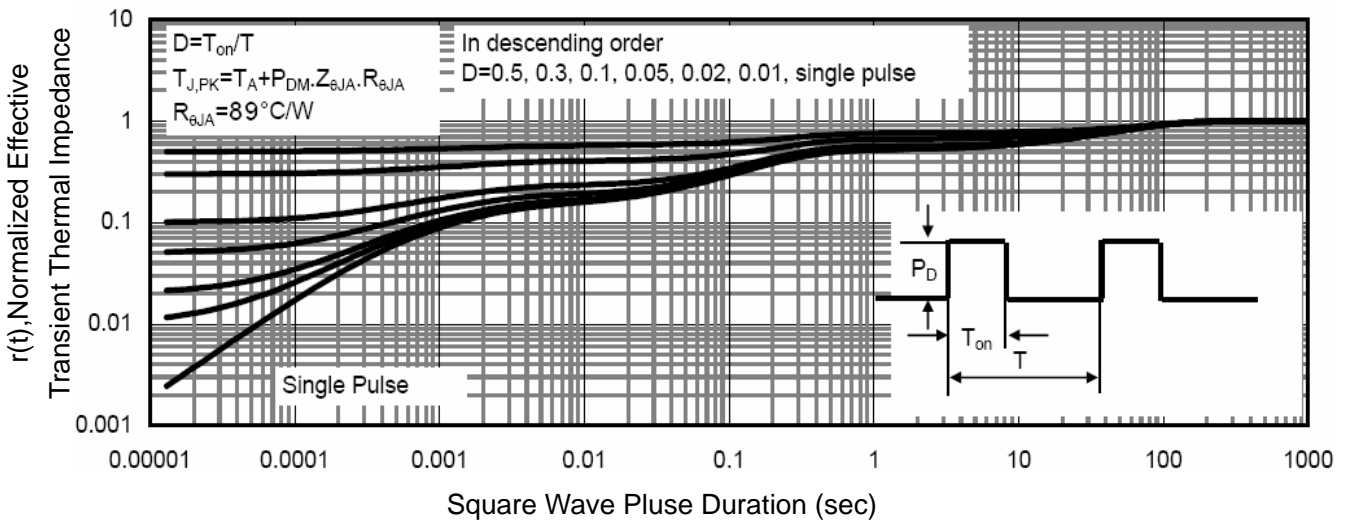
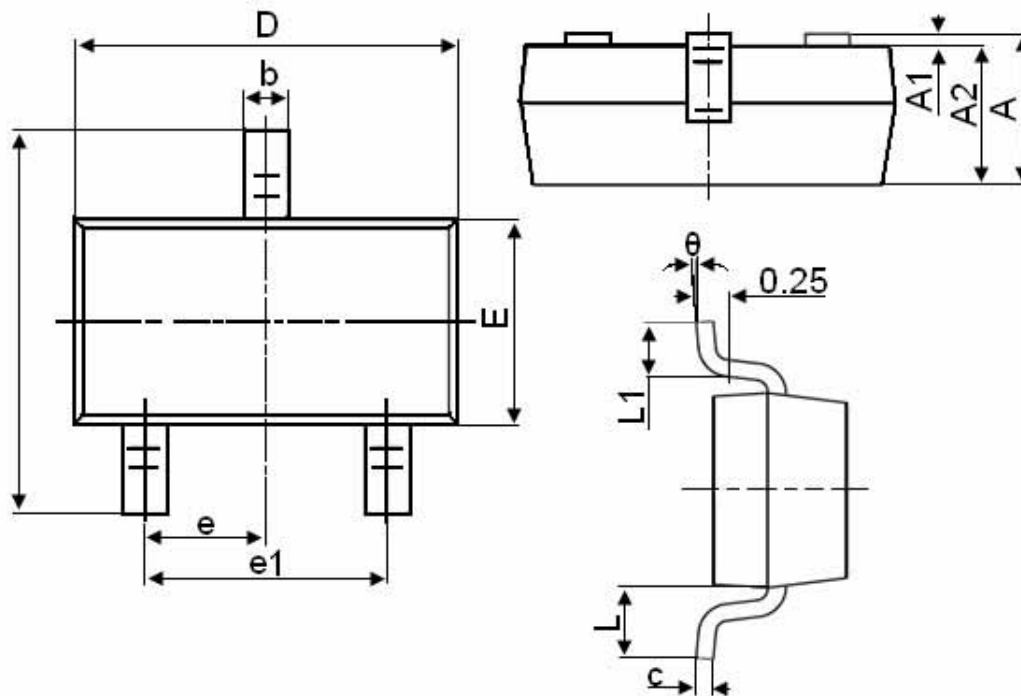

Figure 14 Normalized Maximum Transient Thermal Impedance

SOT-23 Package Information



Symbol	Dimensions in Millimeters	
	MIN.	MAX.
A	0.900	1.150
A1	0.000	0.100
A2	0.900	1.050
b	0.300	0.500
c	0.080	0.150
D	2.800	3.000
E	1.200	1.400
E1	2.250	2.550
e	0.950TYP	
e1	1.800	2.000
L	0.550REF	
L1	0.300	0.500
θ	0°	8°

Notes

1. All dimensions are in millimeters.
2. Tolerance $\pm 0.10\text{mm}$ (4 mil) unless otherwise specified
3. Package body sizes exclude mold flash and gate burrs. Mold flash at the non-lead sides should be less than 5 mils.
4. Dimension L is measured in gauge plane.
5. Controlling dimension is millimeter, converted inch dimensions are not necessarily exact.