

600V(D-S) N-Channel Enhancement Mode Power MOS FET

General Features

- $V_{DS} = 600V, I_D = 4A$
 $R_{DS(ON)} < 2.5 \Omega @ V_{GS} = 10V$
- High density cell design for ultra low R_{dson}
- Fully characterized avalanche voltage and current
- Good stability and uniformity with high E_{AS}
- Excellent package for good heat dissipation
- Special process technology for high ESD capability



Lead Free

Application

- Power switching application
- Hard switched and high frequency circuits
- Uninterruptible power supply

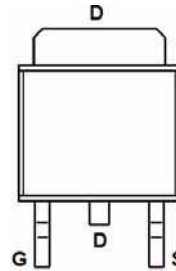

Marking and pin assignment

PIN Configuration

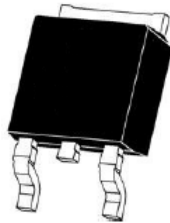

TO-252-2L top view

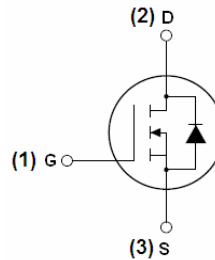

Schematic diagram

Package Marking and Ordering Information

Device Marking	Device	Device Package	Reel Size	Tape width	Quantity
MSN6004D	MSN6004D	TO-252	-	-	2500PCS

Absolute Maximum Ratings ($T_C = 25^\circ C$ unless otherwise noted)

Parameter	Symbol	Limit	Unit
Drain-Source Voltage	V_{DS}	600	V
Gate-Source Voltage	V_{GS}	± 30	V
Drain Current-Continuous	I_D	4	A
Drain Current-Continuous($T_C = 100^\circ C$)	$I_D(100^\circ C)$	3.2	A
Pulsed Drain Current	I_{DM}	16	A
Maximum Power Dissipation	P_D	70	W
Derating factor		0.46	W/ $^\circ C$
Single pulse avalanche energy ^(Note 5)	E_{AS}	240	mJ
Operating Junction and Storage Temperature Range	T_J, T_{STG}	-55 To 150	$^\circ C$

Thermal Characteristic

Thermal Resistance, Junction-to-Case ^(Note 2)	$R_{\theta JC}$	2.6	°C/W
--	-----------------	-----	------

Electrical Characteristics (T_C=25°C unless otherwise noted)

Parameter	Symbol	Condition	Min	Typ	Max	Unit
Off Characteristics						
Drain-Source Breakdown Voltage	BV_{DSS}	$V_{GS}=0V, I_D=250\mu A$	600		-	V
Zero Gate Voltage Drain Current	I_{DSS}	$V_{DS}=600V, V_{GS}=0V$	-	-	10	μA
Gate-Body Leakage Current	I_{GSS}	$V_{GS}=\pm 30V, V_{DS}=0V$	-	-	±100	nA
On Characteristics ^(Note 3)						
Gate Threshold Voltage	$V_{GS(th)}$	$V_{DS}=V_{GS}, I_D=250\mu A$	2		4	V
Drain-Source On-State Resistance	$R_{DS(on)}$	$V_{GS}=10V, I_D=2.0A$	-	-	2.5	Ω
Forward Transconductance	g_{FS}	$V_{DS}=40V, I_D=2A$	-	4.7	-	S
Dynamic Characteristics ^(Note 4)						
Input Capacitance	C_{iss}	$V_{DS}=25V, V_{GS}=0V,$ $F=1.0MHz$	-	710	-	PF
Output Capacitance	C_{oss}		-	65	-	PF
Reverse Transfer Capacitance	C_{rss}		-	14	-	PF
Switching Characteristics ^(Note 4)						
Turn-on Delay Time	$t_{d(on)}$	$V_{DD}=300V, I_D=4A, R_L=25\Omega$ $V_{GS}=10V, R_G=2.5\Omega$	-	20	-	nS
Turn-on Rise Time	t_r		-	55	-	nS
Turn-Off Delay Time	$t_{d(off)}$		-	70	-	nS
Turn-Off Fall Time	t_f		-	55	-	nS
Total Gate Charge	Q_g	$V_{DS}=480V, I_D=4A,$ $V_{GS}=10V$	-	22	-	nC
Gate-Source Charge	Q_{gs}		-	4.8	-	nC
Gate-Drain Charge	Q_{gd}		-	8.5	-	nC
Drain-Source Diode Characteristics						
Diode Forward Voltage ^(Note 3)	V_{SD}	$V_{GS}=0V, I_S=4.0A$	-		1.4	V
Diode Forward Current ^(Note 2)	I_S		-	-	4.0	A
Reverse Recovery Time	t_{rr}	$T_J = 25^\circ C, I_F = 4.0A$ $di/dt = 100A/\mu s$ ^(Note 3)	-	330	-	nS
Reverse Recovery Charge	Q_{rr}		-	2.15	-	μC
Forward Turn-On Time	t_{on}	Intrinsic turn-on time is negligible (turn-on is dominated by LS+LD)				

Notes:

1. Repetitive Rating: Pulse width limited by maximum junction temperature.
2. Surface Mounted on FR4 Board, $t \leq 10$ sec.
3. Pulse Test: Pulse Width $\leq 300\mu s$, Duty Cycle $\leq 2\%$.
4. Guaranteed by design, not subject to production
5. E_{AS} condition: $j=25^\circ C, V_{DD}=50V, V_G=10V, L=0.5mH, R_g=25\Omega$

Typical Electrical and Thermal Characteristics (Curves)

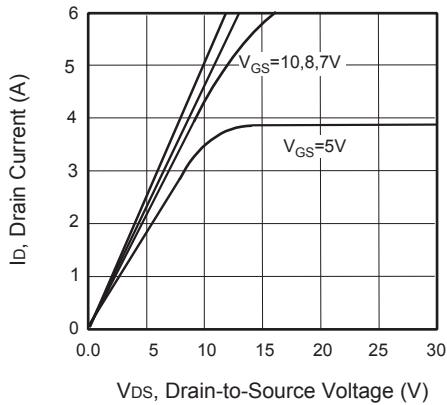

Figure 1. Output Characteristics

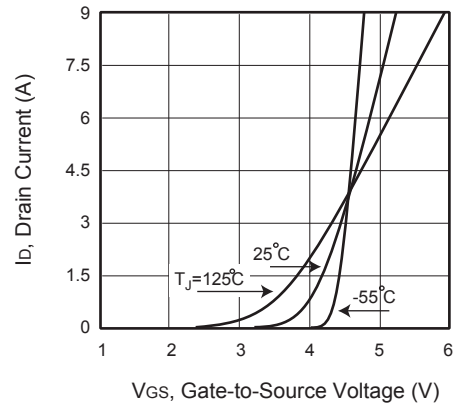

Figure 2. Transfer Characteristics

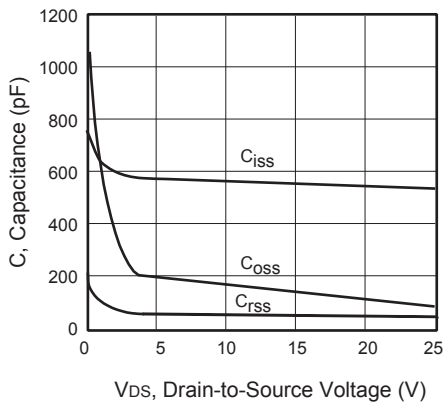

Figure 3. Capacitance

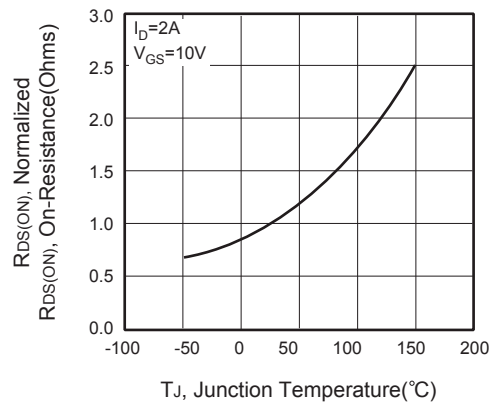

Figure 4. On-Resistance Variation with Temperature

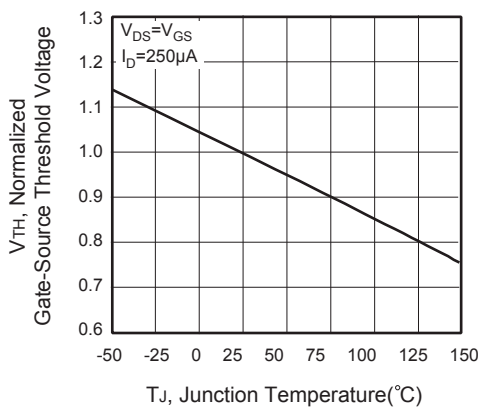

Figure 5. Gate Threshold Variation with Temperature

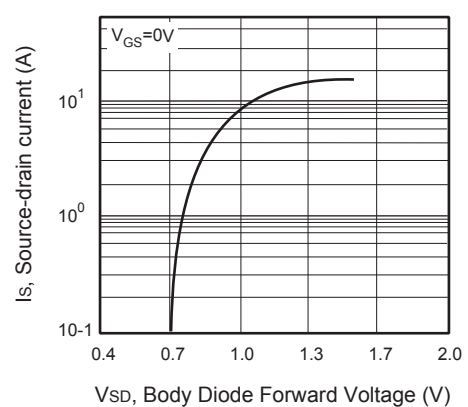

Figure 6. Body Diode Forward Voltage Variation with Source Current

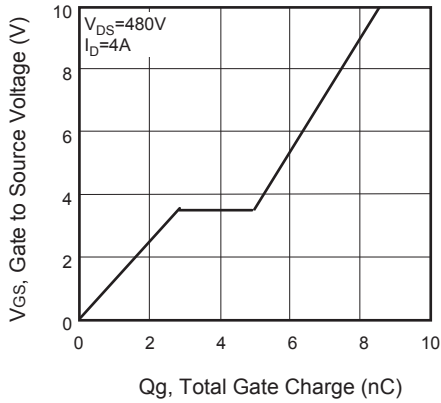

Figure 7. Gate Charge

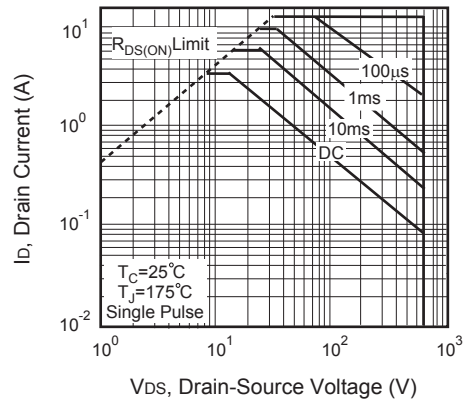

Figure 8. Maximum Safe Operating Area

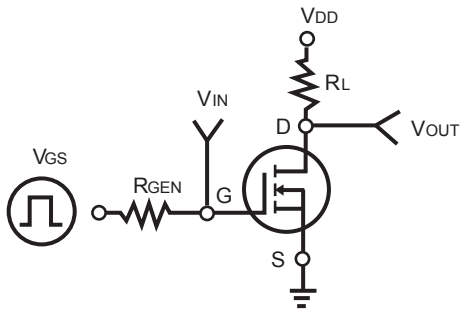

Figure 9. Switching Test Circuit

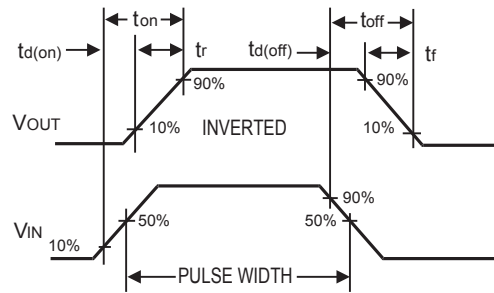

Figure 10. Switching Waveforms

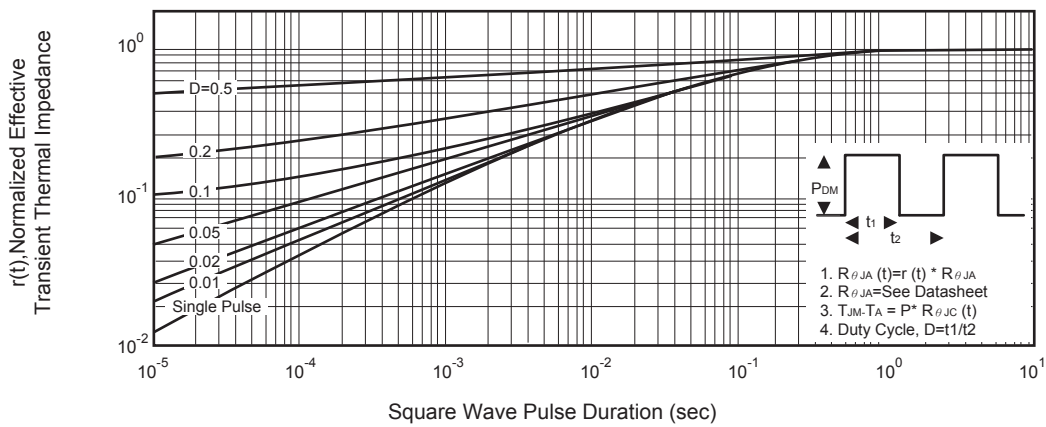
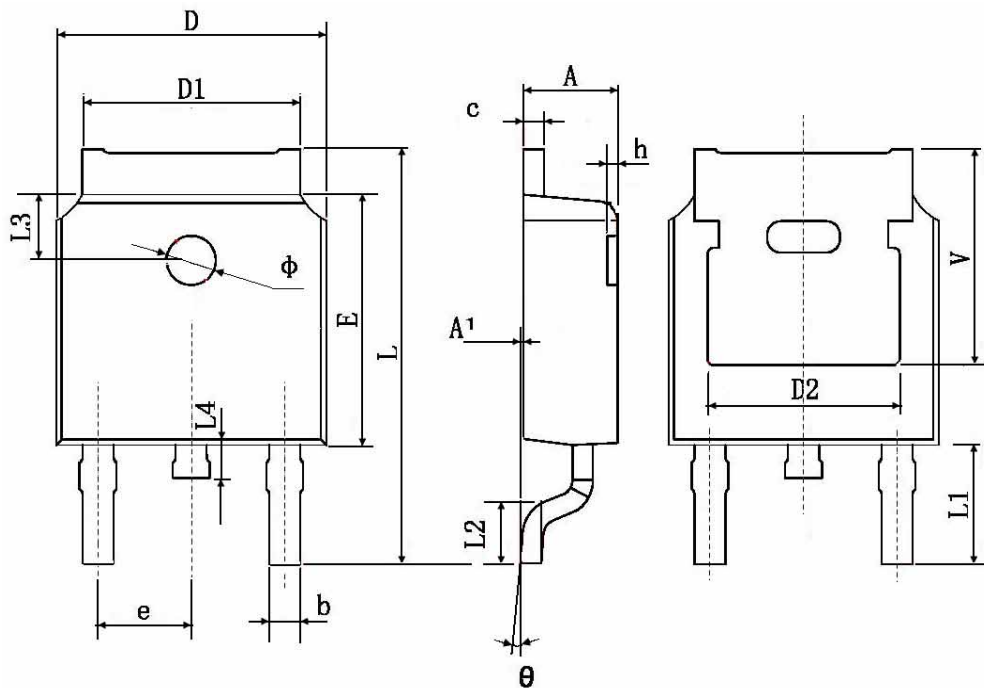

Figure 11. Normalized Thermal Transient Impedance Curve

TO-252 Package Information



Symbol	Dimensions In Millimeters		Dimensions In Inches	
	Min.	Max.	Min.	Max.
A	2.200	2.400	0.087	0.094
A1	0.000	0.127	0.000	0.005
b	0.660	0.860	0.026	0.034
c	0.460	0.580	0.018	0.023
D	6.500	6.700	0.256	0.264
D1	5.100	5.460	0.201	0.215
D2	4.830 TYP.		0.190 TYP.	
E	6.000	6.200	0.236	0.244
e	2.186	2.386	0.086	0.094
L	9.800	10.400	0.386	0.409
L1	2.900 TYP.		0.114 TYP.	
L2	1.400	1.700	0.055	0.067
L3	1.600 TYP.		0.063 TYP.	
L4	0.600	1.000	0.024	0.039
φ	1.100	1.300	0.043	0.051
θ	0°	8°	0°	8°
h	0.000	0.300	0.000	0.012
V	5.350 TYP.		0.211 TYP.	