

30V(D-S) N-Channel Enhancement Mode Power MOS FET

General Features

- $V_{DS} = 30V, I_D = 5.8A$
 $R_{DS(ON)} < 59m\Omega @ V_{GS}=2.5V$
 $R_{DS(ON)} < 45m\Omega @ V_{GS}=4.5V$
 $R_{DS(ON)} < 41m\Omega @ V_{GS}=10V$
- High power and current handing capability
- Lead free product is acquired
- Surface mount package



Lead Free

Application

- PWM applications
- Load switch
- Power management

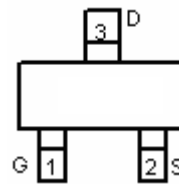

Marking and pin assignment

PIN Configuration



SOT-23 top view

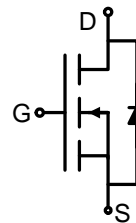

Schematic diagram

Package Marking and Ordering Information

| Device Marking | Device | Device Package | Reel Size | Tape width | Quantity |
|----------------|----------|----------------|-----------|------------|------------|
| | MSN3402A | SOT-23 | Ø180mm | 8 mm | 3000 units |

Absolute Maximum Ratings ($T_A=25^\circ C$ unless otherwise noted)

| Parameter | Symbol | Limit | Unit |
|--|----------------|------------|------------|
| Drain-Source Voltage | V_{DS} | 30 | V |
| Gate-Source Voltage | V_{GS} | ± 12 | V |
| Drain Current-Continuous | I_D | 5.8 | A |
| Drain Current-Pulsed ^(Note 1) | I_{DM} | 30 | A |
| Maximum Power Dissipation | P_D | 1.4 | W |
| Operating Junction and Storage Temperature Range | T_J, T_{STG} | -55 To 150 | $^\circ C$ |

Thermal Characteristic

| | | | |
|---|-----------------|----|--------------|
| Thermal Resistance, Junction-to-Ambient ^(Note 2) | $R_{\theta JA}$ | 89 | $^\circ C/W$ |
|---|-----------------|----|--------------|

Electrical Characteristics (T_A=25°C unless otherwise noted)

| Parameter | Symbol | Condition | Min | Typ | Max | Unit |
|---|---------------------|--|-----|-----|------|------|
| Off Characteristics | | | | | | |
| Drain-Source Breakdown Voltage | BV _{DSS} | V _{GS} =0V, I _D =250μA | 30 | 33 | - | V |
| Zero Gate Voltage Drain Current | I _{DSS} | V _{DS} =30V, V _{GS} =0V | - | - | 1 | μA |
| Gate-Body Leakage Current | I _{GSS} | V _{GS} =±12V, V _{DS} =0V | - | - | ±100 | nA |
| On Characteristics (Note 3) | | | | | | |
| Gate Threshold Voltage | V _{GS(th)} | V _{DS} =V _{GS} , I _D =250μA | 0.7 | 0.9 | 1.4 | V |
| Drain-Source On-State Resistance | R _{DS(on)} | V _{GS} =2.5V, I _D =4A | - | 45 | 59 | mΩ |
| | | V _{GS} =4.5V, I _D =5A | - | 31 | 45 | mΩ |
| | | V _{GS} =10V, I _D =5.8A | - | 28 | 41 | mΩ |
| Forward Transconductance | g _{FS} | V _{DS} =5V, I _D =5A | 10 | - | - | S |
| Dynamic Characteristics (Note 4) | | | | | | |
| Input Capacitance | C _{iss} | V _{DS} =15V, V _{GS} =0V, F=1.0MHz | - | 820 | - | PF |
| Output Capacitance | C _{oss} | | - | 99 | - | PF |
| Reverse Transfer Capacitance | C _{rss} | | - | 77 | - | PF |
| Switching Characteristics (Note 4) | | | | | | |
| Turn-on Delay Time | t _{d(on)} | V _{DD} =15V, R _L =2.7Ω V _{GS} =10V, R _{GEN} =3Ω | - | 3.3 | - | nS |
| Turn-on Rise Time | t _r | | - | 4.8 | - | nS |
| Turn-Off Delay Time | t _{d(off)} | | - | 26 | - | nS |
| Turn-Off Fall Time | t _f | | - | 4 | - | nS |
| Total Gate Charge | Q _g | V _{DS} =15V, I _D =5.8A, V _{GS} =4.5V | - | 9.5 | - | nC |
| Gate-Source Charge | Q _{gs} | | - | 1.5 | - | nC |
| Gate-Drain Charge | Q _{gd} | | - | 3 | - | nC |
| Drain-Source Diode Characteristics | | | | | | |
| Diode Forward Voltage | V _{SD} | V _{GS} =0V, I _S =5.8A | - | - | 1.2 | V |
| Diode Forward Current | I _S | | - | - | 5.8 | A |

Notes:

1. Repetitive Rating: Pulse width limited by maximum junction temperature.
2. Surface Mounted on FR4 Board, t ≤ 10 sec.
3. Pulse Test: Pulse Width ≤ 300μs, Duty Cycle ≤ 2%.
4. Guaranteed by design, not subject to production

Typical Electrical and Thermal Characteristics

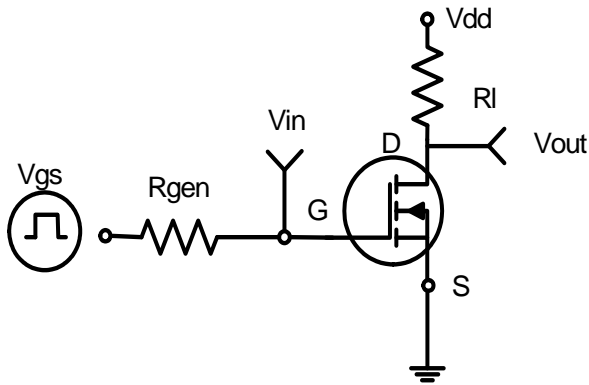

Figure 1: Switching Test Circuit

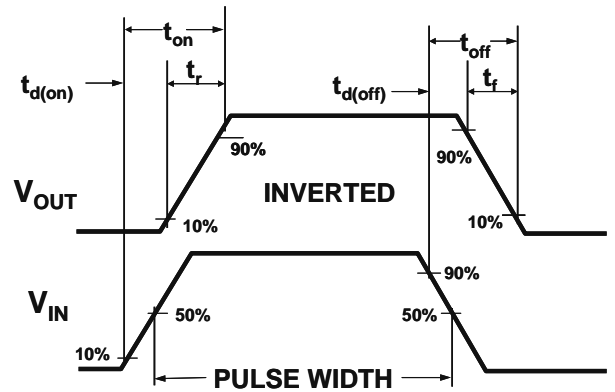

Figure 2: Switching Waveforms

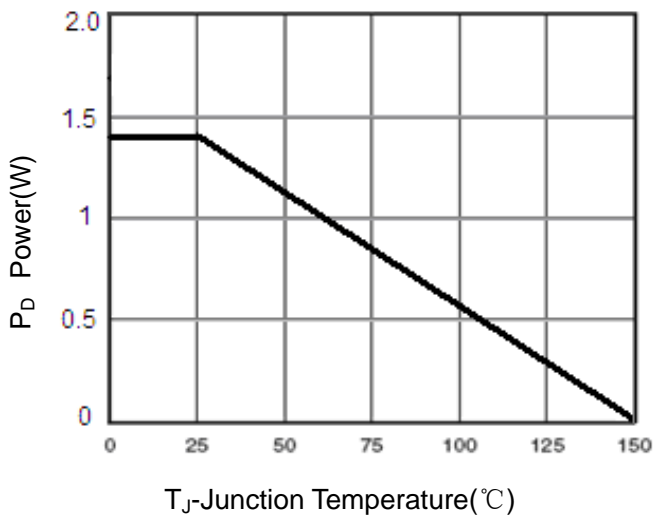

Figure 3 Power Dissipation

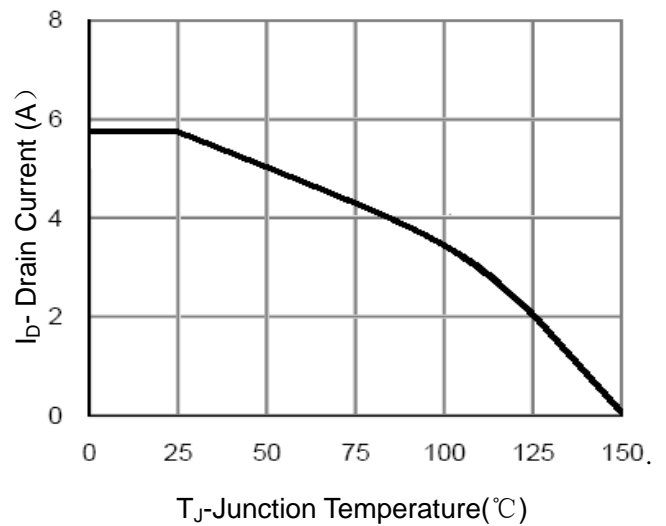

Figure 4 Drain Current

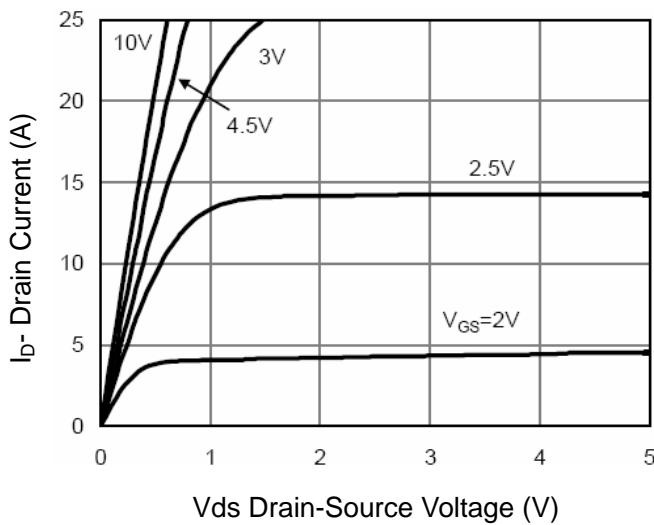

Figure 5 Output Characteristics

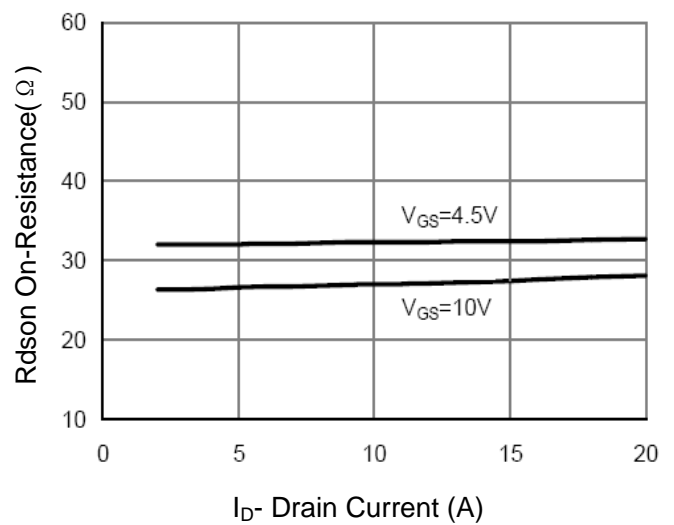

Figure 6 Drain-Source On-Resistance

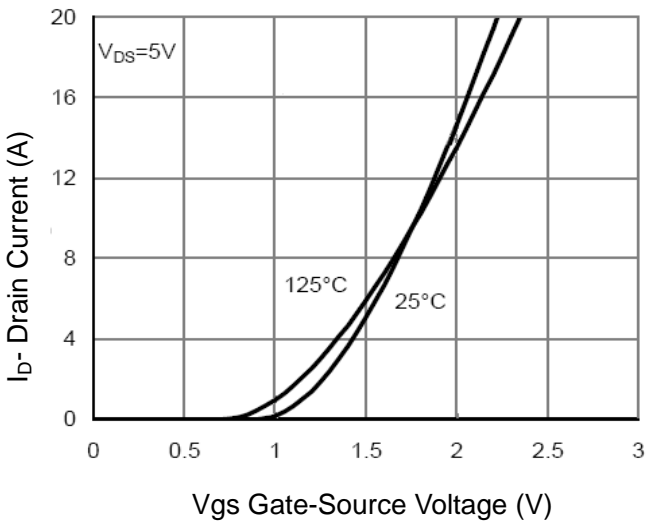

Figure 7 Transfer Characteristics

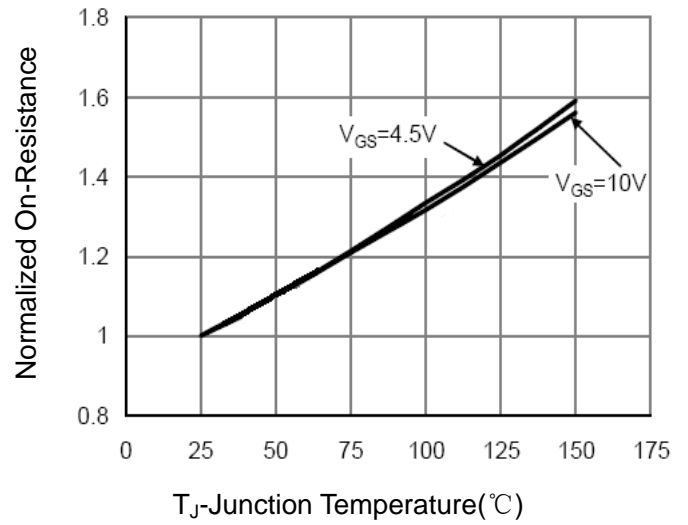

Figure 8 Drain-Source On-Resistance

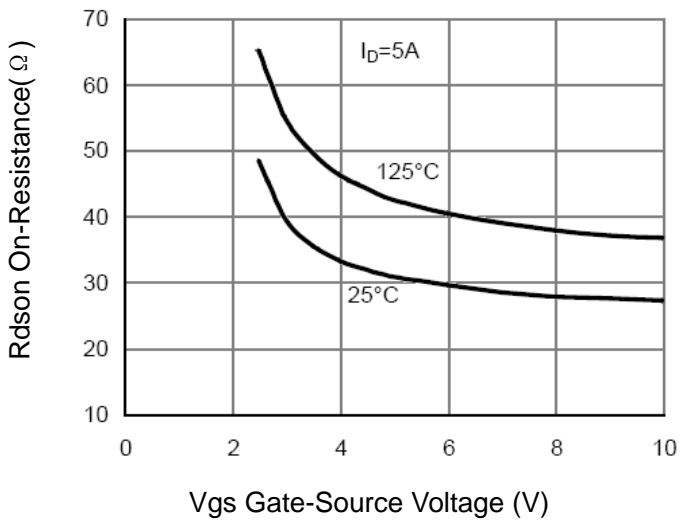

Figure 9 Rdson vs Vgs

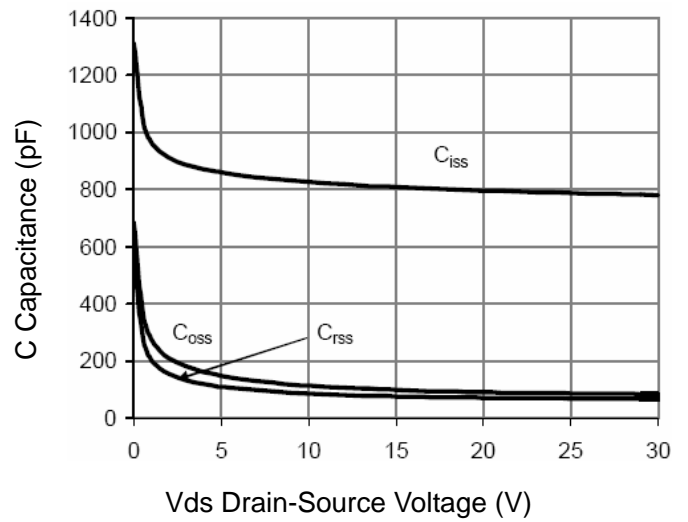

Figure 10 Capacitance vs Vds

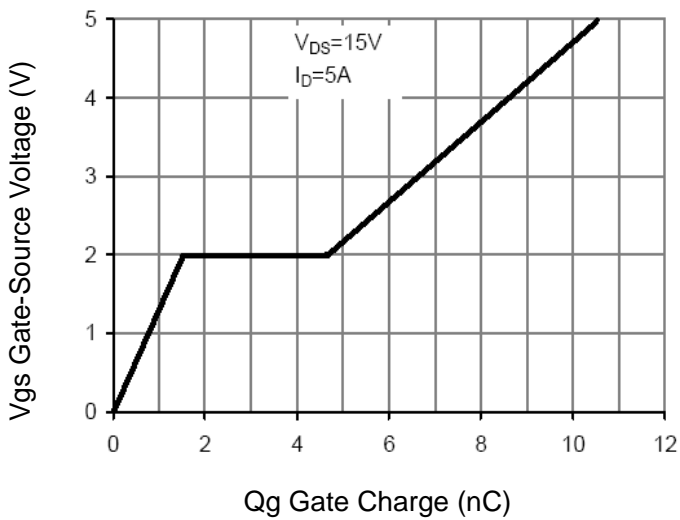

Figure 11 Gate Charge

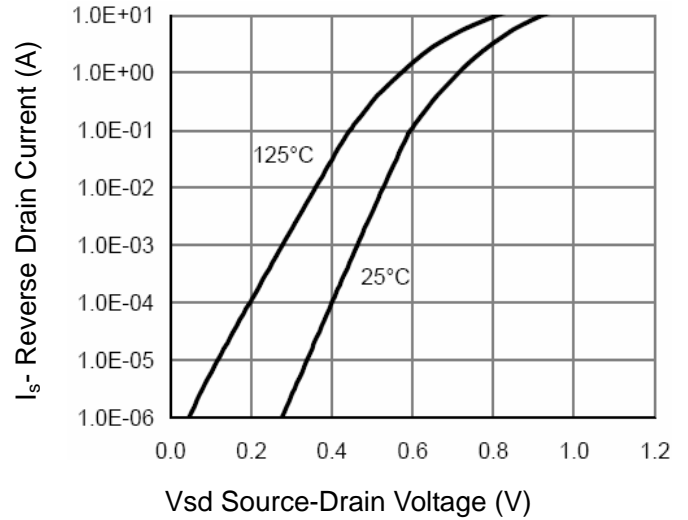

Figure 12 Source- Drain Diode Forward

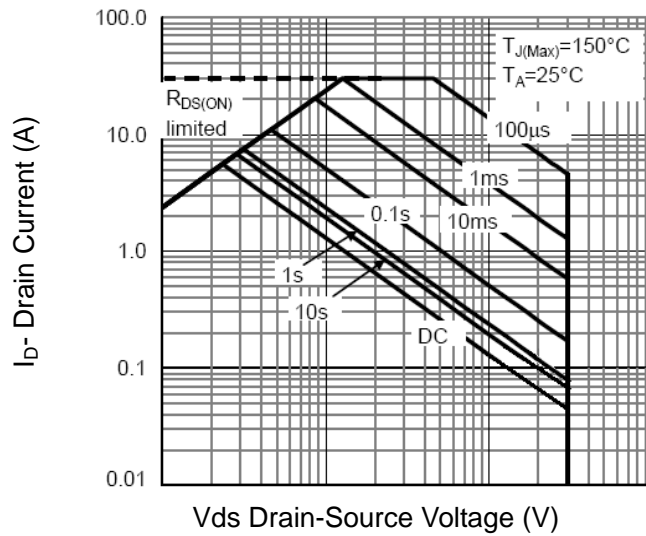

Figure 13 Safe Operation Area

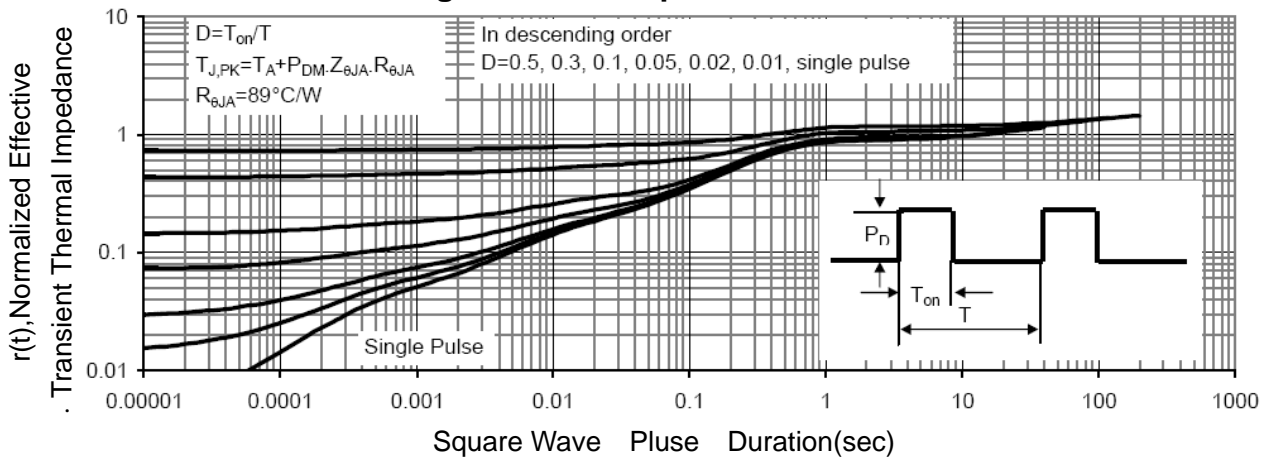
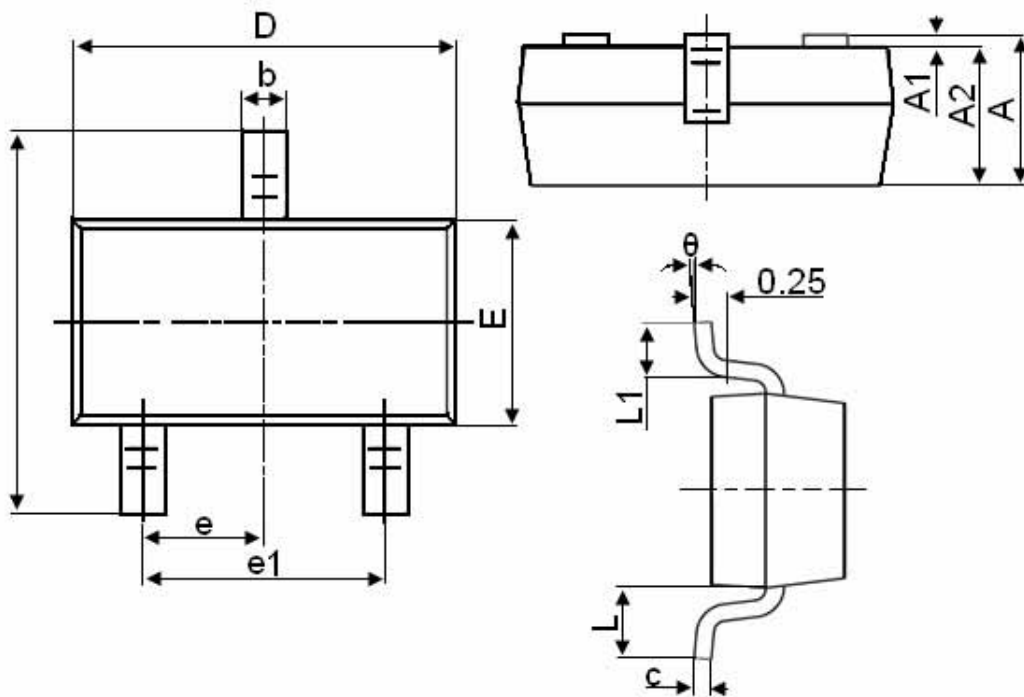

Figure 14 Normalized Maximum Transient Thermal Impedance

SOT-23 Package Information



| Symbol | Dimensions in Millimeters | |
|----------|---------------------------|-------|
| | MIN. | MAX. |
| A | 0.900 | 1.150 |
| A1 | 0.000 | 0.100 |
| A2 | 0.900 | 1.050 |
| b | 0.300 | 0.500 |
| c | 0.080 | 0.150 |
| D | 2.800 | 3.000 |
| E | 1.200 | 1.400 |
| E1 | 2.250 | 2.550 |
| e | 0.950TYP | |
| e1 | 1.800 | 2.000 |
| L | 0.550REF | |
| L1 | 0.300 | 0.500 |
| θ | 0° | 8° |

Notes

1. All dimensions are in millimeters.
2. Tolerance $\pm 0.10\text{mm}$ (4 mil) unless otherwise specified
3. Package body sizes exclude mold flash and gate burrs. Mold flash at the non-lead sides should be less than 5 mils.
4. Dimension L is measured in gauge plane.
5. Controlling dimension is millimeter, converted inch dimensions are not necessarily exact.