

50V(D-S) N-Channel Enhancement Mode Power MOS FET

General Features

- $V_{DS} = 50V, I_D = 0.22A$
 $R_{DS(ON)} < 3\Omega @ V_{GS}=5V$
 $R_{DS(ON)} < 2\Omega @ V_{GS}=10V$
- Lead free product is acquired
- Surface mount package



Lead Free

Application

- Direct logic-level interface: TTL/CMOS
- Drivers: relays, solenoids, lamps, hammers, display, memories, transistors, etc.
- Battery operated systems
- Solid-state relays

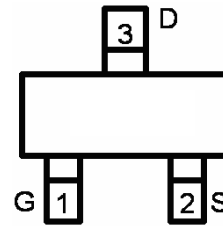

Marking and pin assignment

PIN Configuration



SOT-23 top view

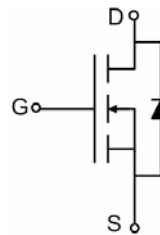

Schematic diagram

Package Marking and Ordering Information

Device Marking	Device	Device Package	Reel Size	Tape width	Quantity
	MSN138	SOT-23	Ø180mm	8 mm	3000 units

Absolute Maximum Ratings ($T_A=25^\circ C$ unless otherwise noted)

Parameter	Symbol	Limit	Unit
Drain-Source Voltage	V_{DS}	50	V
Gate-Source Voltage	V_{GS}	± 20	V
Drain Current-Continuous	I_D	0.22	A
Drain Current-Pulsed ^(Note 1)	I_{DM}	0.88	A
Maximum Power Dissipation	P_D	0.35	W
Operating Junction and Storage Temperature Range	T_J, T_{STG}	-55 To 150	$^\circ C$

Thermal Characteristic

Thermal Resistance, Junction-to-Ambient ^(Note 2)	$R_{\theta JA}$	350	$^\circ C/W$
---	-----------------	-----	--------------

Electrical Characteristics (T_A=25°C unless otherwise noted)

Parameter	Symbol	Condition	Min	Typ	Max	Unit
Off Characteristics						
Drain-Source Breakdown Voltage	BV _{DSS}	V _{GS} =0V I _D =250μA	50	65	-	V
Zero Gate Voltage Drain Current	I _{DSS}	V _{DS} =50V, V _{GS} =0V	-	-	0.5	μA
Gate-Body Leakage Current	I _{GSS}	V _{GS} =±20V, V _{DS} =0V	-	-	±100	nA
On Characteristics (Note 3)						
Gate Threshold Voltage	V _{GS(th)}	V _{DS} =V _{GS} , I _D =250μA	0.8	1.2	1.6	V
Drain-Source On-State Resistance	R _{DS(ON)}	V _{GS} =5V, I _D =0.05A	-	1.2	3	Ω
		V _{GS} =10V, I _D =0.5A	-	1	2	Ω
Forward Transconductance	g _{FS}	V _{DS} =10V, I _D =0.2A	0.12	-	-	S
Dynamic Characteristics (Note 4)						
Input Capacitance	C _{iss}	V _{DS} =25V, V _{GS} =0V, F=1.0MHz	-	27	-	PF
Output Capacitance	C _{oss}		-	12	-	PF
Reverse Transfer Capacitance	C _{rss}		-	6	-	PF
Switching Characteristics (Note 4)						
Turn-on Delay Time	t _{d(on)}	V _{DD} =30V, I _D =0.22A V _{GS} =10V, R _{GEN} =6Ω	-	2.5	-	nS
Turn-on Rise Time	t _r		-	6	-	nS
Turn-Off Delay Time	t _{d(off)}		-	20	-	nS
Turn-Off Fall Time	t _f		-	7	-	nS
Total Gate Charge	Q _g	V _{DS} =25V, I _D =0.3A, V _{GS} =10V	-	1.7	2.4	nC
Drain-Source Diode Characteristics						
Diode Forward Voltage (Note 3)	V _{SD}	V _{GS} =0V, I _S =0.22A	-	-	1.3	V
Diode Forward Current (Note 2)	I _S	-	-	-	0.22	A

Notes:

1. Repetitive Rating: Pulse width limited by maximum junction temperature.
2. Surface Mounted on FR4 Board, t ≤ 10 sec.
3. Pulse Test: Pulse Width ≤ 300μs, Duty Cycle ≤ 2%.
4. Guaranteed by design, not subject to production

Typical Electrical and Thermal Characteristics

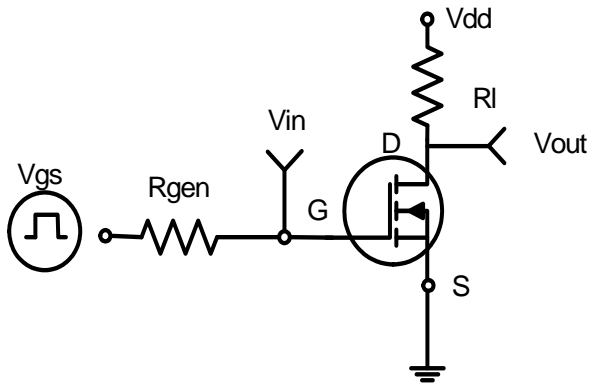

Figure 1: Switching Test Circuit

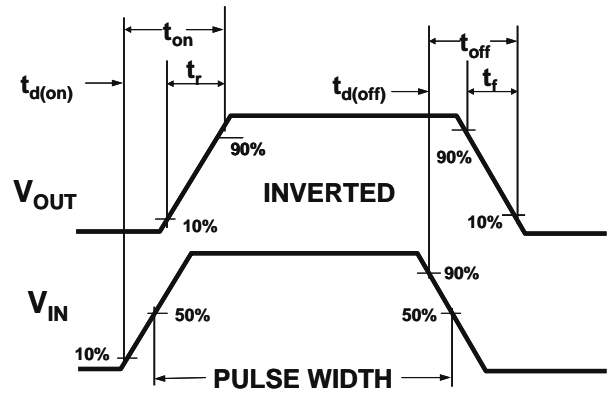

Figure 2: Switching Waveforms

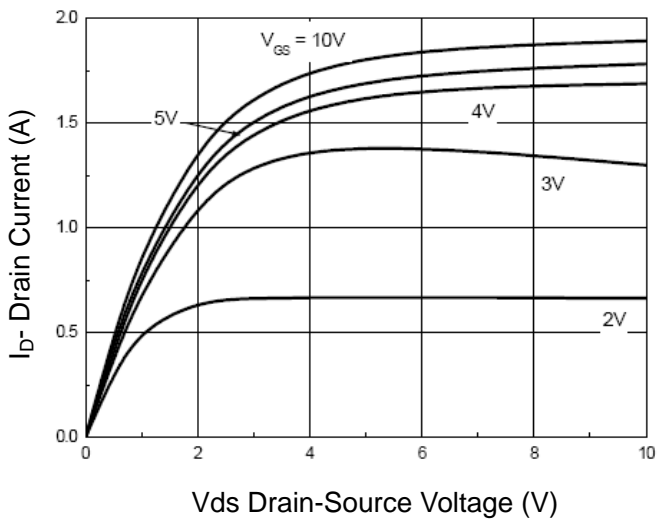

Figure 3 Output Characteristics

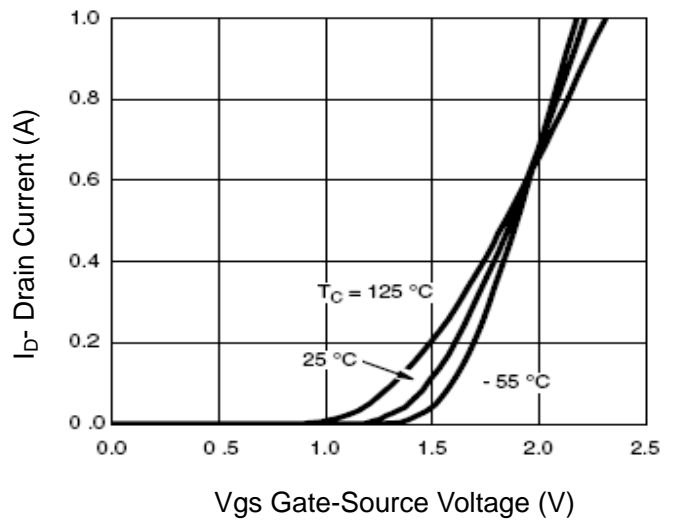

Figure 4 Transfer Characteristics

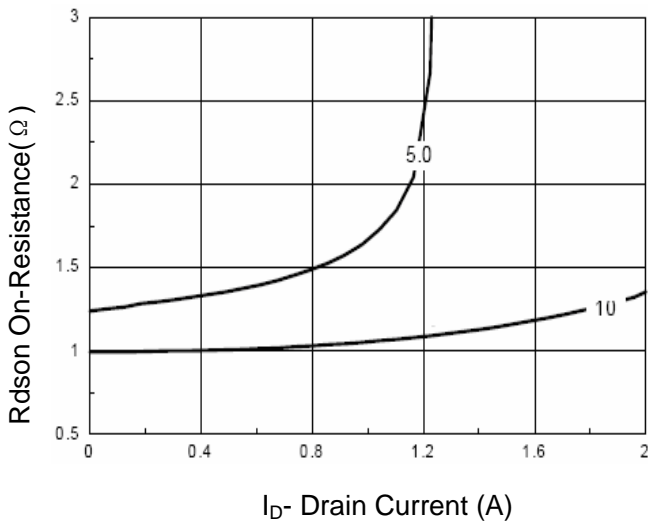

Figure 5 Drain-Source On-Resistance

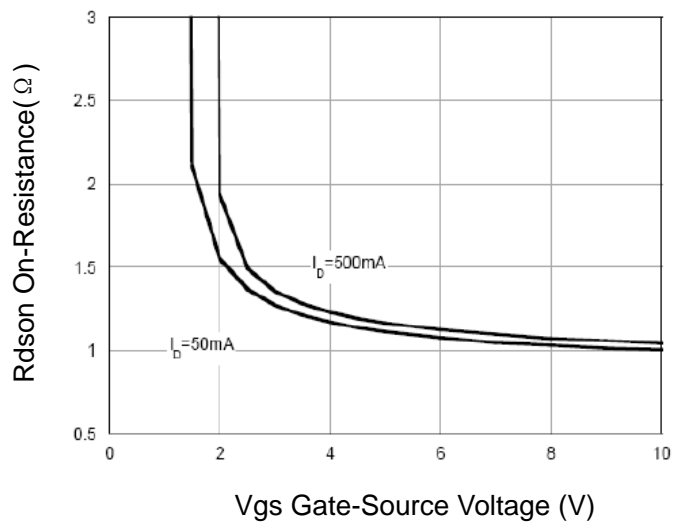
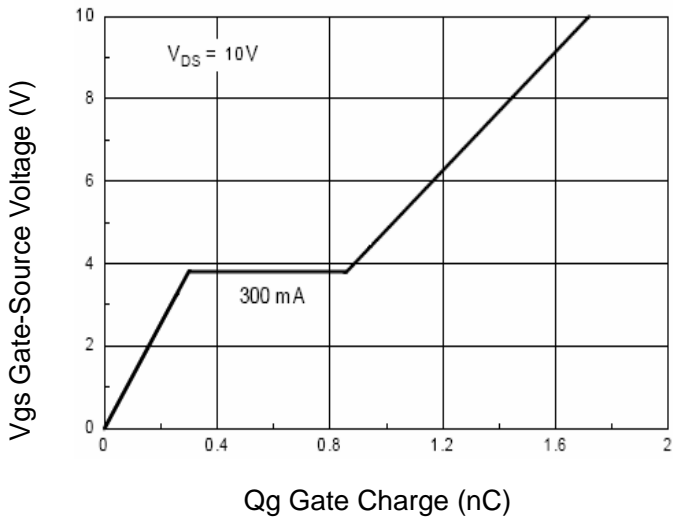
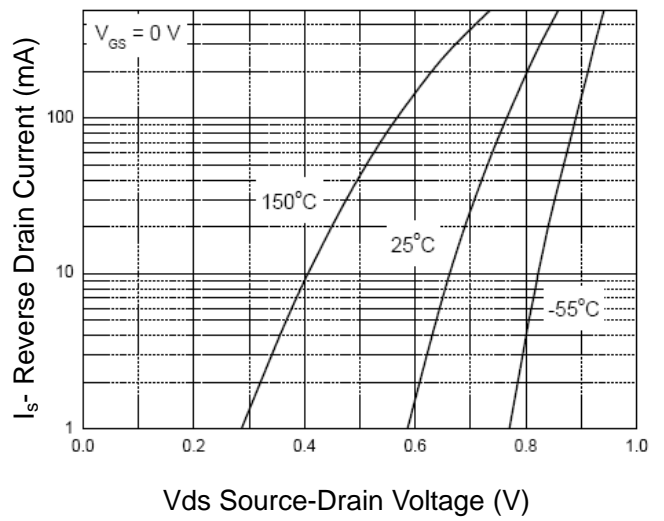

Figure 6 Rdson vs Vgs



Qg Gate Charge (nC)
Figure 7 Gate Charge



Vds Source-Drain Voltage (V)
Figure 8 Source-Drain Diode Forward

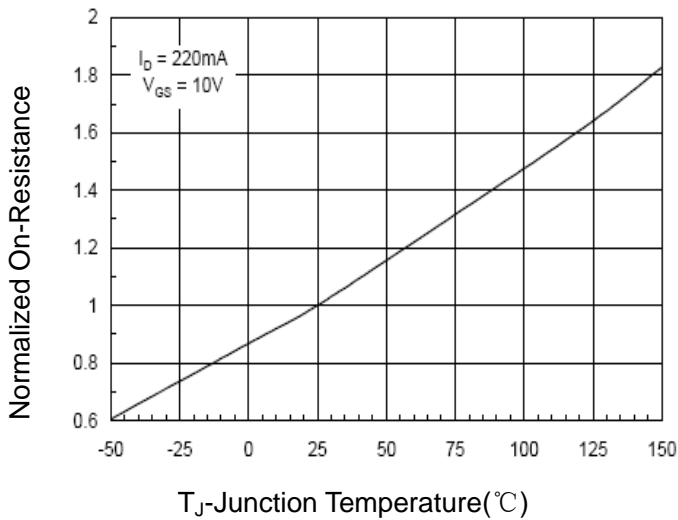

TJ-Junction Temperature(°C)
Figure 9 Drain-Source On-Resistance

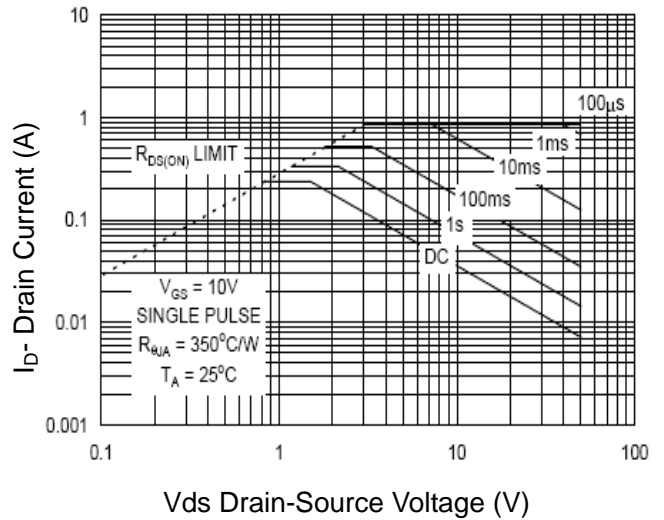

Vds Drain-Source Voltage (V)
Figure 10 Safe Operation Area

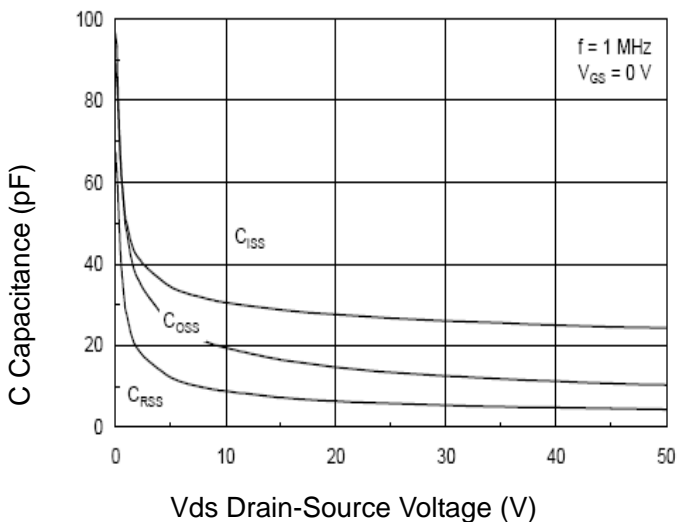

Vds Drain-Source Voltage (V)
Figure 11 Capacitance vs Vds

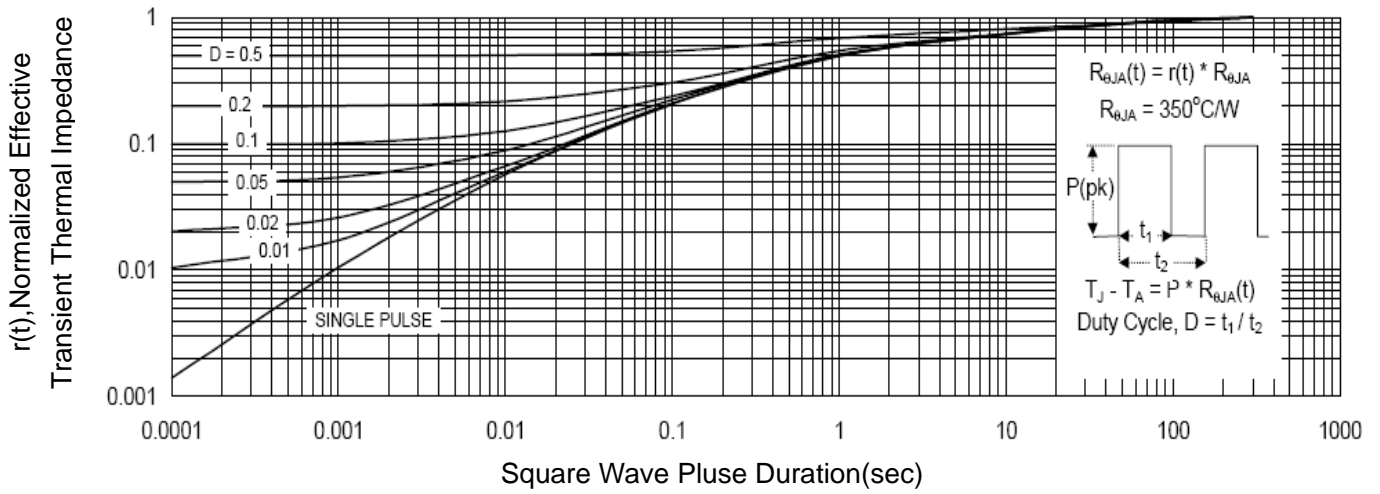
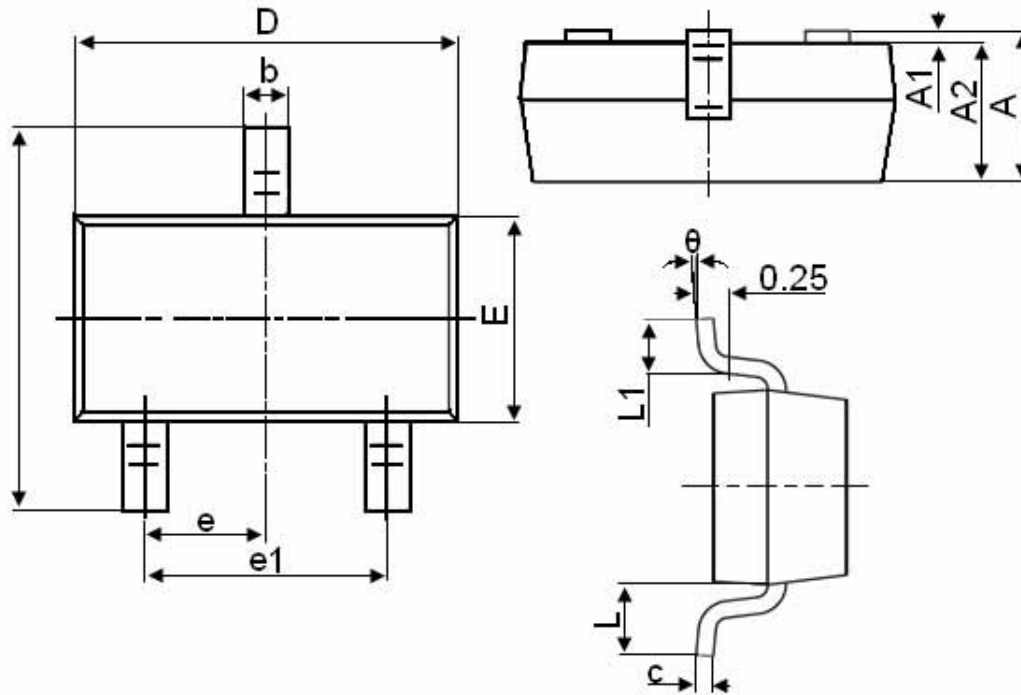

Figure 12 Normalized Maximum Transient Thermal Impedance

SOT-23 Package Information



Symbol	Dimensions in Millimeters	
	MIN.	MAX.
A	0.900	1.150
A1	0.000	0.100
A2	0.900	1.050
b	0.300	0.500
c	0.080	0.150
D	2.800	3.000
E	1.200	1.400
E1	2.250	2.550
e	0.950TYP	
e1	1.800	2.000
L	0.550REF	
L1	0.300	0.500
θ	0°	8°

Notes

1. All dimensions are in millimeters.
2. Tolerance $\pm 0.10\text{mm}$ (4 mil) unless otherwise specified
3. Package body sizes exclude mold flash and gate burrs. Mold flash at the non-lead sides should be less than 5 mils.
4. Dimension L is measured in gauge plane.
5. Controlling dimension is millimeter, converted inch dimensions are not necessarily exact.