

20V(D-S) Dual N-Channel Enhancement Mode Power MOS FET

**General Features**

- $V_{DS} = 20V, I_D = 6A$   
 $R_{DS(ON)} < 28m\Omega @ V_{GS} = 4.5V$   
 $R_{DS(ON)} < 37m\Omega @ V_{GS} = 2.5V$
- High density cell design for ultra low  $R_{ds(on)}$
- Fully characterized avalanche voltage and current



**Lead Free**

**Application**

- Power switching application
- Hard switched and high frequency circuits
- Uninterruptible power supply

**PIN Configuration**

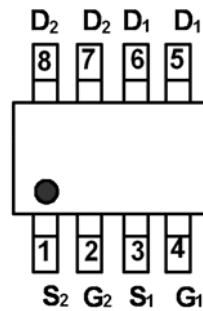

Marking and pin Assignment

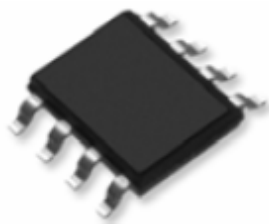

SOP-8 top view

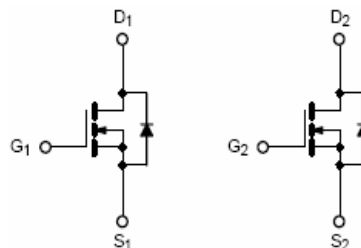

Schematic diagram

**Package Marking and Ordering Information**

Device Marking	Device	Device Package	Reel Size	Tape width	Quantity
	MSC9926W	SOP-8	Ø330mm	12mm	2500 units

**Absolute Maximum Ratings ( $T_A = 25^\circ C$  unless otherwise noted)**

Parameter	Symbol	Limit	Unit
Drain-Source Voltage	$V_{DS}$	20	V
Gate-Source Voltage	$V_{GS}$	$\pm 10$	V
Drain Current-Continuous	$I_D$	6	A
Drain Current-Continuous( $T_C = 100^\circ C$ )	$I_D(100^\circ C)$	3.8	A
Pulsed Drain Current	$I_{DM}$	25	A
Maximum Power Dissipation	$P_D$	1.25	W
Operating Junction and Storage Temperature Range	$T_J, T_{STG}$	-55 To 150	$^\circ C$

**Thermal Characteristic**

Thermal Resistance, Junction-to-Ambient <sup>(Note 2)</sup>	$R_{\theta JA}$	100	$^\circ C/W$
---	-----------------	-----	--------------

**Electrical Characteristics (T<sub>A</sub>=25°C unless otherwise noted)**

Parameter	Symbol	Condition	Min	Typ	Max	Unit
<b>Off Characteristics</b>						
Drain-Source Breakdown Voltage	BV <sub>DSS</sub>	V <sub>GS</sub> =0V, I <sub>D</sub> =250μA	20	22	-	V
Zero Gate Voltage Drain Current	I <sub>DSS</sub>	V <sub>DS</sub> =20V, V <sub>GS</sub> =0V	-	-	1	μA
Gate-Body Leakage Current	I <sub>GSS</sub>	V <sub>GS</sub> =±10V, V <sub>DS</sub> =0V	-	-	±100	nA
<b>On Characteristics (Note 3)</b>						
Gate Threshold Voltage	V <sub>GS(th)</sub>	V <sub>DS</sub> =V <sub>GS</sub> , I <sub>D</sub> =250μA	0.5		1.2	V
Drain-Source On-State Resistance	R <sub>DS(ON)</sub>	V <sub>GS</sub> =4.5V, I <sub>D</sub> =6A	-	21	28	mΩ
		V <sub>GS</sub> =2.5V, I <sub>D</sub> =5A	-	26	37	
Forward Transconductance	g <sub>FS</sub>	V <sub>DS</sub> =5V, I <sub>D</sub> =6A	20	-	-	S
<b>Dynamic Characteristics (Note 4)</b>						
Input Capacitance	C <sub>iss</sub>	V <sub>DS</sub> =10V, V <sub>GS</sub> =0V, F=1.0MHz	-	640	-	PF
Output Capacitance	C <sub>oss</sub>		-	140	-	PF
Reverse Transfer Capacitance	C <sub>rss</sub>		-	80	-	PF
<b>Switching Characteristics (Note 4)</b>						
Turn-on Delay Time	t <sub>d(on)</sub>	V <sub>DD</sub> =10V, I <sub>D</sub> =1A V <sub>GEN</sub> =4.5V, R <sub>G</sub> =6Ω	-	8	-	nS
Turn-on Rise Time	t <sub>r</sub>		-	9	-	nS
Turn-Off Delay Time	t <sub>d(off)</sub>		-	15	-	nS
Turn-Off Fall Time	t <sub>f</sub>		-	4	-	nS
Total Gate Charge	Q <sub>g</sub>	V <sub>DS</sub> =10V, I <sub>D</sub> =3A, V <sub>GS</sub> =4.5V	-	10	-	nC
Gate-Source Charge	Q <sub>gs</sub>		-	1.5	-	nC
Gate-Drain Charge	Q <sub>gd</sub>		-	1.6	-	nC
<b>Drain-Source Diode Characteristics</b>						
Diode Forward Voltage (Note 3)	V <sub>SD</sub>	V <sub>GS</sub> =0V, I <sub>S</sub> =1.7A	-	-	1.2	V
Diode Forward Current (Note 2)	I <sub>S</sub>		-	-	6	A

**Notes:**

1. Repetitive Rating: Pulse width limited by maximum junction temperature.
2. Surface Mounted on FR4 Board, t ≤ 10 sec.
3. Pulse Test: Pulse Width ≤ 300μs, Duty Cycle ≤ 2%.
4. Guaranteed by design, not subject to production

**Test Circuit**

**1) E<sub>AS</sub> Test Circuits**

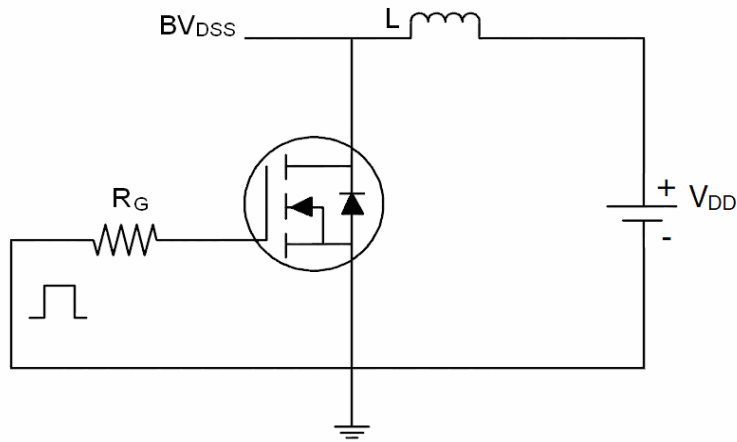

**2) Gate Charge Test Circuit:**

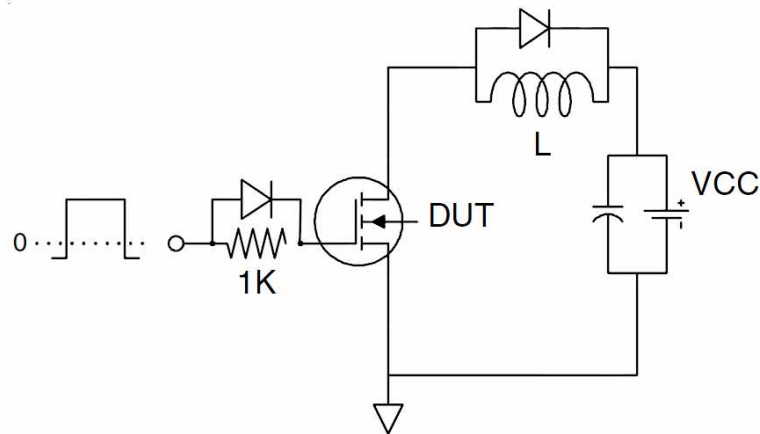

**3) Switch Time Test Circuit:**

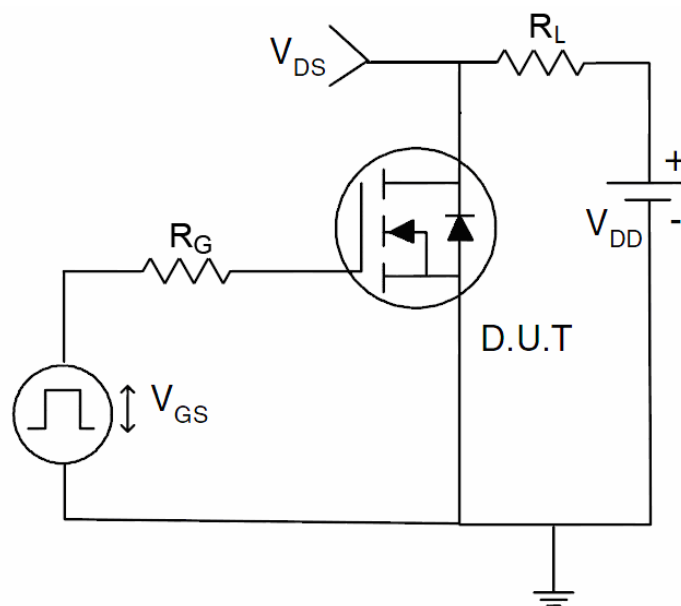

Typical Electrical and Thermal Characteristics (Curves)

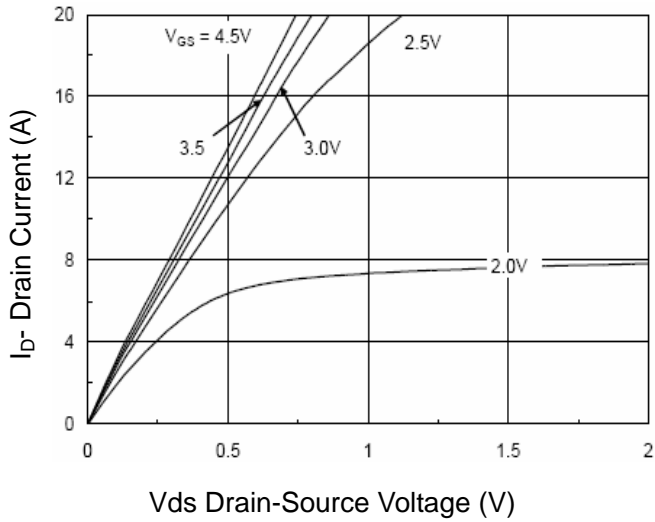

Figure 1 Output Characteristics

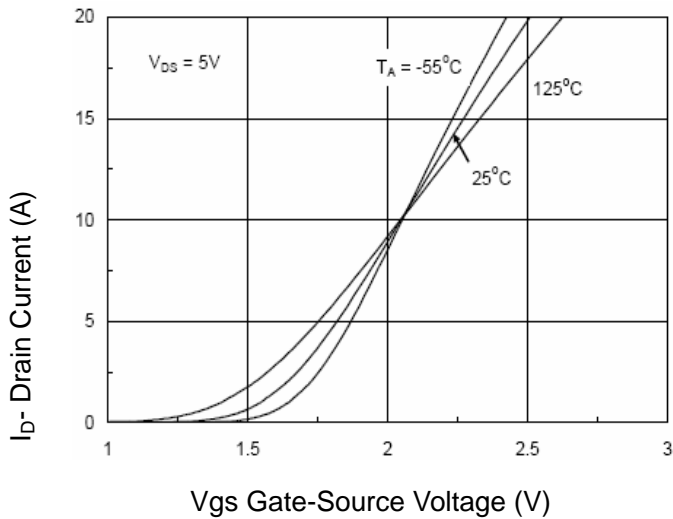

Figure 2 Transfer Characteristics

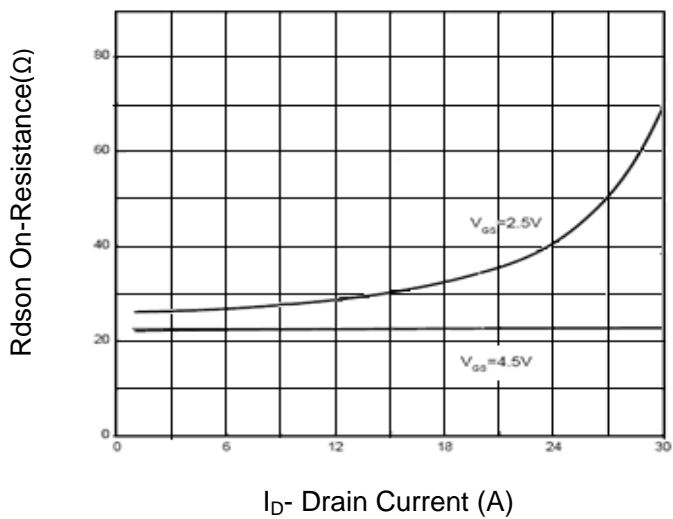

Figure 3  $R_{DS(on)}$ - Drain Current

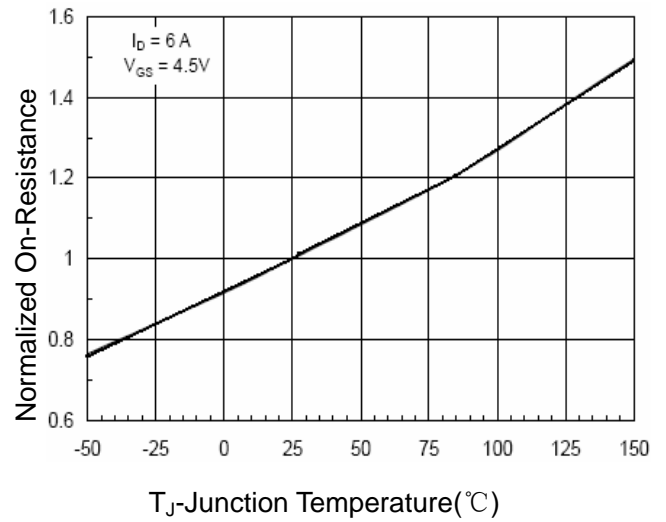

Figure 4  $R_{DS(on)}$ -Junction Temperature

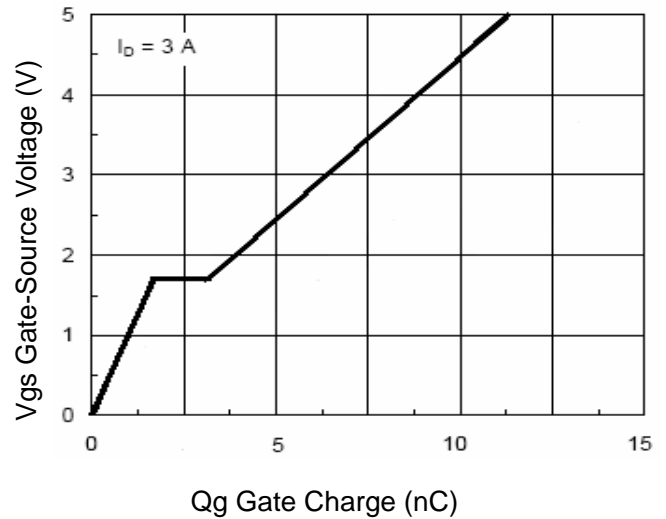

Figure 5 Gate Charge

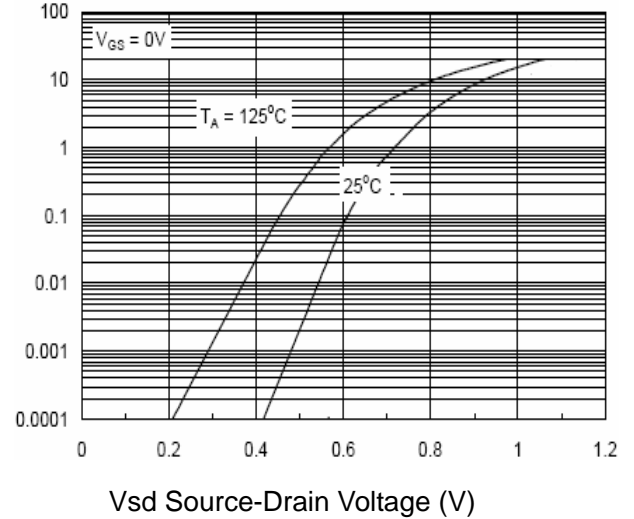

Figure 6 Source- Drain Diode Forward

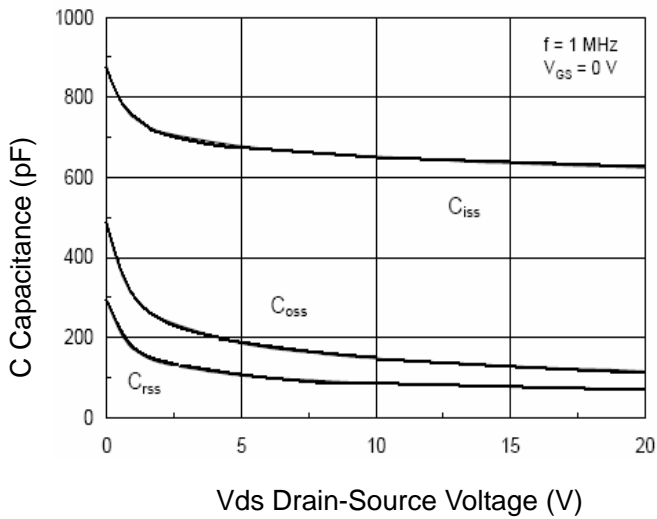

Figure 7 Capacitance vs Vds

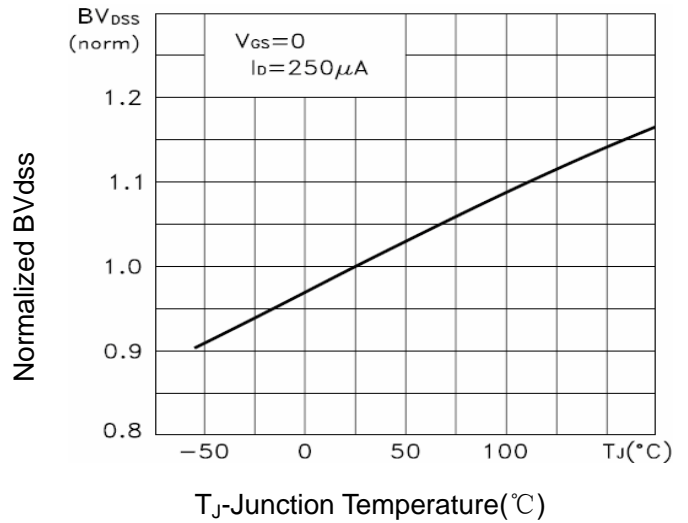

Figure 9  $BV_{DSS}$  vs Junction Temperature

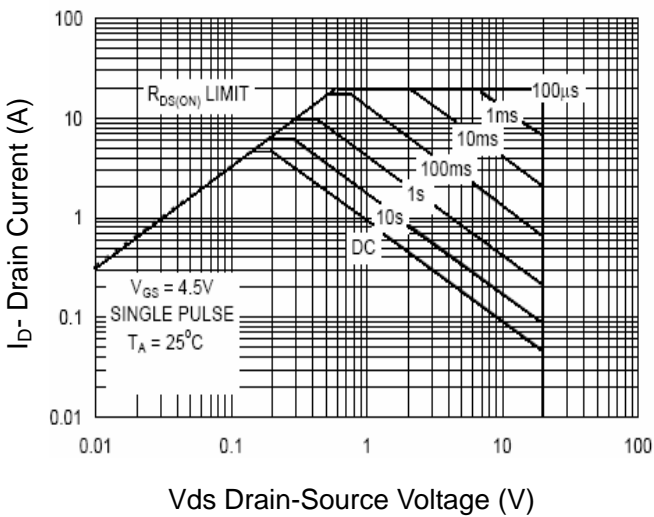

Figure 8 Safe Operation Area

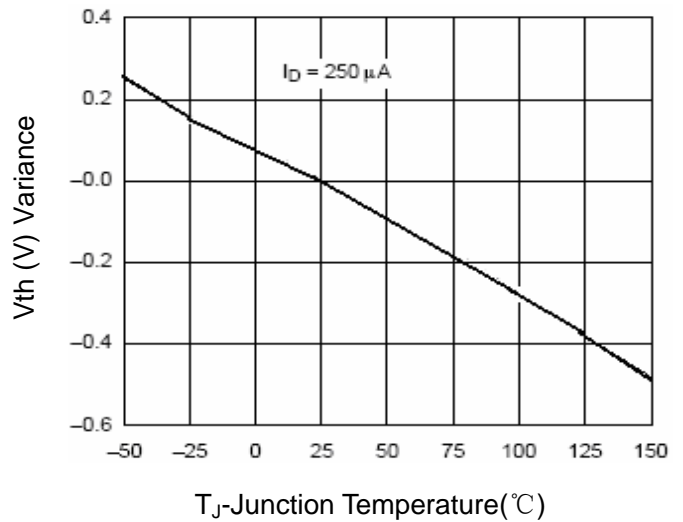

Figure 10  $V_{GS(th)}$  vs Junction Temperature

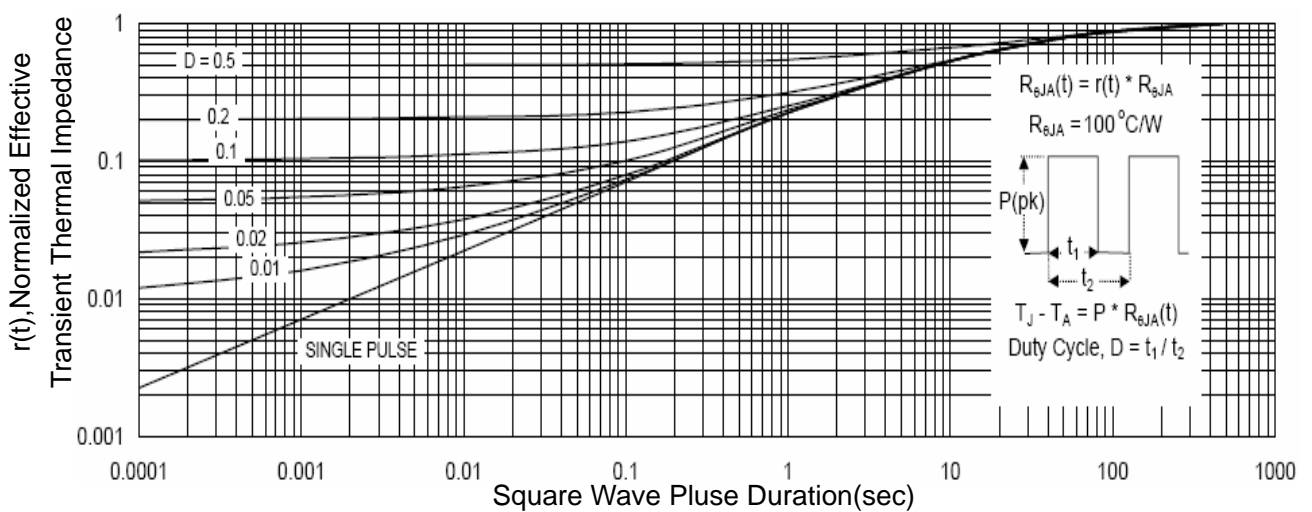
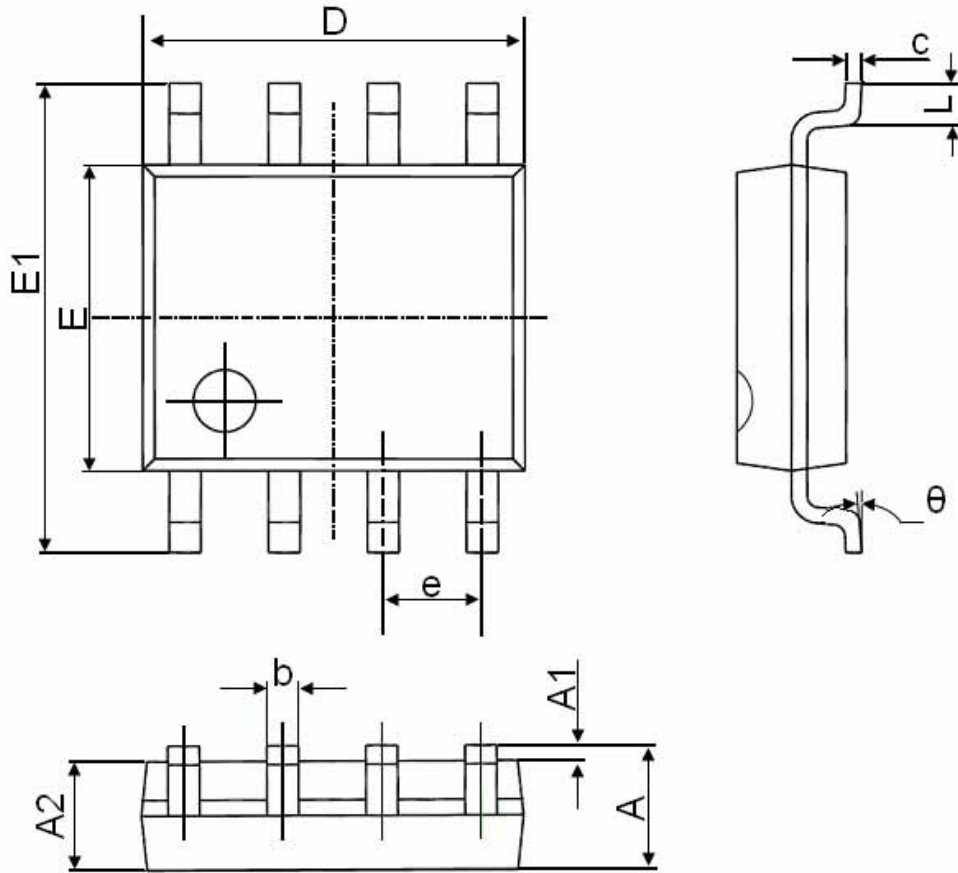

Figure 11 Normalized Maximum Transient Thermal Impedance

**SOP-8 Package Information**



Symbol	Dimensions In Millimeters		Dimensions In Inches	
	Min.	Max.	Min.	Max.
A	1.350	1.750	0.053	0.069
A1	0.100	0.250	0.004	0.010
A2	1.350	1.550	0.053	0.061
b	0.330	0.510	0.013	0.020
c	0.170	0.250	0.006	0.010
D	4.700	5.100	0.185	0.200
E	3.800	4.000	0.150	0.157
E1	5.800	6.200	0.228	0.244
e	1.270(BSC)		0.050(BSC)	
L	0.400	1.270	0.016	0.050
theta	0°	8°	0°	8°